

IMPORTANT SAFETY INSTRUCTIONS

FOR HOUSEHOLD USE ONLY

WARNING

When using an electrical appliance, to reduce the risk of fire, electric shock, injury, or property damage, basic precautions should always be followed, including the following:

READ ALL INSTRUCTIONS BEFORE USING THIS VACUUM:

- This vacuum consists of a motorized nozzle, wand, and handheld vacuum. These components contain electrical connections, electrical wiring, and moving parts that potentially present risk to the user. The floor nozzle, wand, and handheld vacuum contain electrical connections.
- Before each use, carefully inspect all parts for any damage. If a part is damaged, discontinue use.
- Use only identical replacement parts.
- This vacuum contains no serviceable parts.
- Use only as described in this manual. **DO NOT** use the vacuum for any purpose other than those described in this manual.
- With the exception of the filters and dust cup, **DO NOT** expose any parts of the vacuum to water or other liquids.
- Keep the appliance and its cord out of reach of children. Do not allow the appliance to be used by children. **DO NOT** allow to be used as a toy. Close supervision is necessary when used near children.

GENERAL USE

- This appliance can be used by persons with reduced physical, sensory or mental capabilities or lack of experience and knowledge if they have been given supervision or instruction concerning use of the appliance in a safe way and understand the hazards involved. Cleaning and user maintenance shall not be made by children.
- Always turn off the vacuum before connecting or disconnecting any current carrying hoses, motorized nozzles, chargers, batteries, or other electrical or mechanical parts.
- DO NOT** handle plug or vacuum with wet hands.
- DO NOT** use without dust cup, HEPA and Pre-motor filter, and soft roller in place.
- Only use Shark® branded filters and accessories. Failure to do so will void the warranty.
- DO NOT** put any objects into nozzle or accessory openings. **DO NOT** use with any opening blocked; keep free of dust, lint, hair, and anything that may reduce airflow.
- DO NOT** use if nozzle or accessory airflow is restricted. If the air paths or the motorized floor nozzle become blocked, turn the vacuum off. Remove all obstructions before you turn on the unit again.
- Keep nozzle and all vacuum openings away from hair, face, fingers, uncovered feet, or loose clothing.
- DO NOT** use if vacuum is not working as it should, or has been dropped, damaged, left outdoors, or dropped into water.
- Use extra care when cleaning on stairs.
- DO NOT** leave the vacuum unattended while powered on.
- When powered on, keep the vacuum moving over the carpet surface at all times to avoid damaging the carpet fibers.
- DO NOT** place vacuum on unstable surfaces such as chairs or tables.
- DO NOT** use to pick up:
 - Liquids
 - Large objects
 - Hard or sharp objects (glass, nails, screws, or coins)
 - Large quantities of dust (including drywall, fireplace ash, or embers). **DO NOT** use as an attachment to power tools for dust collection.
 - Smoking or burning objects (hot coals, cigarette butts, or matches)
 - Flammable or combustible materials (lighter fluid, gasoline, or kerosene)
 - Toxic materials (chlorine bleach, ammonia, or drain cleaner)
- DO NOT** use in the following areas:
 - Poorly lit areas
 - Wet or damp surfaces

- Outdoor areas
- Spaces that are enclosed and may contain explosive or toxic fumes or vapors (lighter fluid, gasoline, kerosene, paint, paint thinners, mothproofing substances, or flammable dust)

- Turn off the vacuum before plugging in or unplugging the charger.
- Turn off the vacuum before any adjustment, cleaning, maintenance or troubleshooting.
- During cleaning or routine maintenance, **DO NOT** cut anything other than hair, fibers, or string wrapped around the brushroll.
- Allow all filters to air-dry completely before replacing in the vacuum to prevent liquid from being drawn into electric parts.
- DO NOT** modify or attempt to repair the vacuum or the battery yourself, except as indicated in this manual. **DO NOT** use the battery or vacuum if it has been modified or damaged. Damaged or modified batteries may exhibit unpredictable behavior resulting in fire, explosion or risk of injury.

- Always turn off this appliance before connecting or disconnecting motorized nozzle or hand tool.

BATTERY PACK

- The battery is the power source for the vacuum. Carefully read and follow all charging instructions.
- To prevent unintentional starting, ensure the vacuum is powered off before picking up or carrying the vacuum. **DO NOT** carry the appliance with your finger on the power switch.
- Use only Shark® charger for single batteries for dual battery packs. Use of an incorrect charger may result in no charging, and/or unsafe conditions. A charger that is suitable for one type of battery pack may create a risk of fire when used with another battery pack.
- Keep the battery away from all metal objects such as paper clips, coins, keys, nails, or screws. Shorting the battery terminals increases the risk of fire or burns.
- Under abusive conditions, liquid may be ejected from the battery. Avoid contact with this liquid, as it may cause irritation or burns. If contact occurs, flush with water. If liquid contacts eyes, seek medical help.
- Battery should not be stored at temperatures below 3°C (37.4°F) or above 104°F (40°C) to maintain long-term battery life.
- DO NOT** charge battery at temperatures below 5°C (40°F) or above 104°F (40°C). Charging improperly or at temperatures outside of the specified range may damage the battery and increase the risk of fire.
- Store the appliance indoors. **DO NOT** use or store it below 3°C (37.4°F). Ensure the appliance is at room temperature before operating.
- DO NOT** expose the battery to fire or temperatures above 265°F (130°C) as it may cause explosion.
- Use appliances only with specifically designated battery packs. Use of any other battery packs may create a risk of injury and fire.
- Disconnect the battery pack from the appliance before making any adjustments, changing accessories, or storing appliance. Such preventive safety measures reduce the risk of starting the appliance accidentally.
- For IZ640H, IZ641H, IZ642H use only with Shark battery pack XBATF725 and for IZ662H, IZ682H, IZ683H use only with Shark battery pack XBATR725.
- If the charging cord plug does not fit fully into the outlet, reverse the plug. If it still does not fit, contact a qualified electrician. **DO NOT** force into outlet or try to modify to fit.
- To reduce the risk of shock and unintended operation, turn off power and remove the Li-Ion battery before servicing.

SAVE THESE INSTRUCTIONS

ASSEMBLY

- Insert **Wand** into **Floor Nozzle**.
 - Insert **Handheld Vacuum** into wand.
- For proper operation, ensure all components are completely connected and clicked into place.

Handheld Vacuum with Non-Removable Battery
IZ640 Series

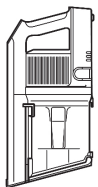

OR

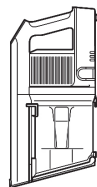

Handheld Vacuum with Removable Battery
IZ660/IZ680 Series

2. (Click)

Multiflex® Wand

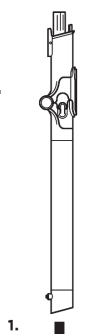

NOTE: Your Quick Guide shows the accessories that are included with your model.

* Accessories may vary depending on the model.

1. (Click)

DuoClean® PowerFins™ Floor Nozzle



LI-ION BATTERY

The Lithium Ion Power Pack battery does not come fully charged. Prior to first use, charge completely. During first use, run the battery down until it is completely out of power. This will condition the battery.

LED BATTERY POWER AND CHARGING INDICATORS

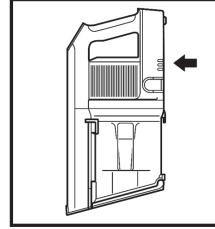

Charging

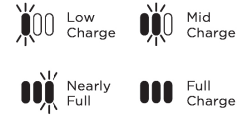

Additional Notes

- LEDs turn off once the battery is fully charged.
- Unit will not power on when charger is connected.

ABOUT YOUR ION POWER PACK BATTERY

This product uses a lithium-ion rechargeable and recyclable battery. When the battery no longer holds a charge, it should be removed from the vacuum and recycled. **DO NOT** incinerate or compost the battery.

When your Lithium Ion Power Pack Battery needs to be replaced, dispose of it or recycle it in accordance with local regulations. In some areas, it is illegal to place spent lithium-ion batteries in the bin or in a municipal solid waste stream. Return spent power packs to an authorized recycling center or to retailer for recycling. Contact your local recycling center for information on where to drop off the spent power pack.

SUCTION POWER MODES

SUCTION MODE DISPLAY LIGHTS	ECO Mode
○○○ Off	Maximum runtime. Saves battery power.
●○○ ECO	Deep Clean Mode Best balance between suction power and optimized runtime.
●●○ Deep Clean	Boost Mode Maximum suction. Uses the most battery power.

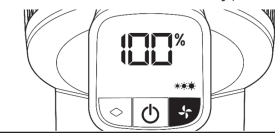

Battery Runtime

MODE	MINUTES	
	IZ640H IZ641H IZ642H	IZ682H IZ683H
Hand Vac - ECO Mode	60	120
Bare Floor Mode - ECO Mode	46	92
Carpet Mode - ECO Mode	30	60
Boost Mode (Hand Vac)	10	20

Suction mode impacts runtime. Use BOOST in short bursts.

CHARGING THE BATTERY

USING THE LI-ION CHARGER

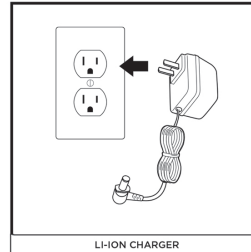

Plug the Li-Ion Charger into a wall outlet.

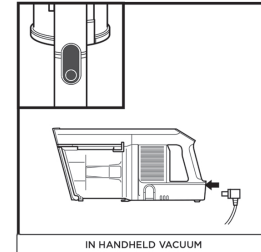

To charge the battery inside the handheld vacuum, connect the charger to an electrical outlet, then insert the charger plug into the port below the handle on the handheld vacuum.

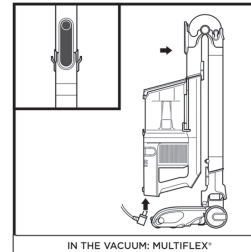

To put the vacuum in storage mode, press the **Multiflex Wand Unlock Latch** while folding the handheld vacuum forward until the wand clicks and locks. Plug the charger into the charging port on the handheld vacuum.

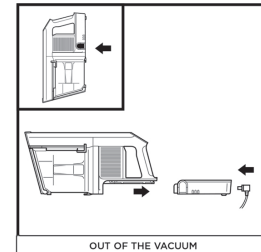

If battery is removable (IZ660 and IZ680 Series), press and hold the **Battery Release Button**, then slide out the battery. Plug the charger into the charging port on the battery. To reinstall the battery, slide it into the slot in the back of the handheld vacuum.

SETTINGS

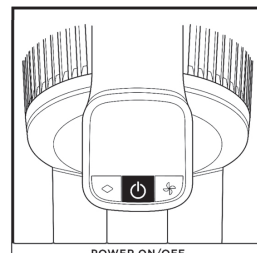

POWER ON/OFF

Press power button to turn vacuum on or off.

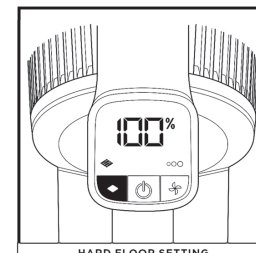

HARD FLOOR SETTING

To vacuum in hard floor mode, press the floor select button until the hard floor icon (⬠) illuminates. The brushrolls will spin slowly to clean bare floors and small area rugs.

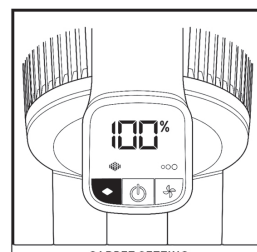

CARPET SETTING

To vacuum in carpet mode, press the floor select button until the carpet icon (⬠) illuminates. The brushrolls will spin faster to pick up debris below the surface of your carpets.

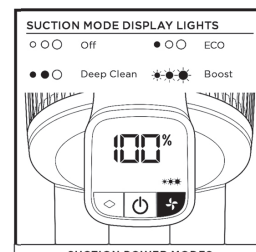

SUCTION POWER MODES

Press the (⬠) button to toggle between ECO, Deep Clean, and Boost modes. To save battery power, select ECO mode. For everyday cleaning power, select Deep Clean Mode. For an extra burst of power, select Boost mode.

CLEANING MODES

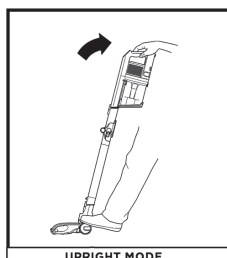

UPRIGHT MODE

To clean floors, step on floor nozzle and tilt handheld vacuum back.

NOTE: Brushrolls will only engage when the handheld vacuum is tilted back.

Illustrations may differ from actual product. We are constantly striving to improve our products; therefore the specifications contained herein are subject to change without notice.

NOTE: For proper operation, please ensure that all parts are firmly pressed until CLICKED in place.

TECHNICAL SPECIFICATIONS

Voltage: 25.2V

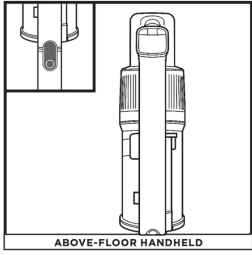

ABOVE-FLOOR HANDHELD

Press the wand release button and lift the handheld vacuum off the wand. Attach an accessory for great cleaning on stairs, furniture, and other above-floor areas.

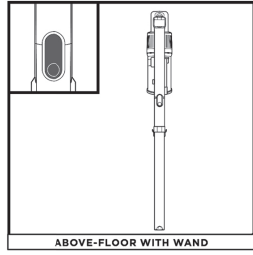

ABOVE-FLOOR WITH WAND

Stand the vacuum upright and press the nozzle release button located at the bottom of the wand, above the nozzle. Lift wand to detach. Great for cleaning baseboards, ceiling fans, window sills, and other hard-to-access areas.

NOTE: All accessories are compatible with both the wand and the handheld vacuum.

USING THE MULTIFLEX® WAND

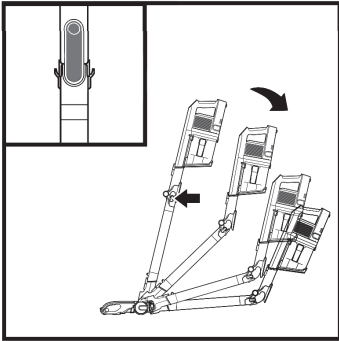

Press the unlock latch on the back of the wand, then adjust the angle.

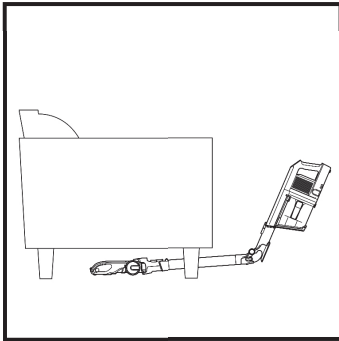

Adjust the wand to a lower angle to easily clean under furniture.

MULTIFLEX STORAGE

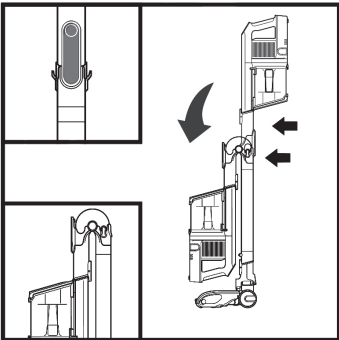

To put the vacuum in storage mode, press the unlock latch while folding the handheld vacuum forward.

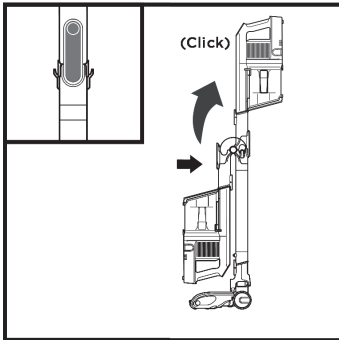

To take the vacuum out of storage mode, press the unlock latch and lift up the handheld vacuum until the wand clicks and locks into place.

MAINTAINING YOUR VACUUM

EMPTYING THE DUST CUP

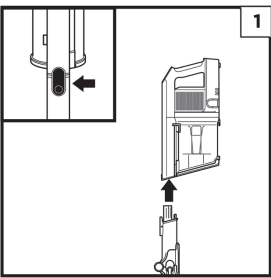

Press the wand release button to detach the handheld vacuum from the wand.

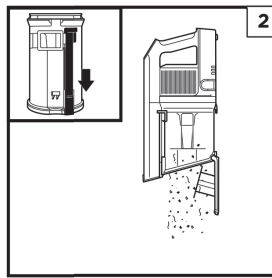

To empty the **Dust Cup** while it is attached to the handheld vacuum, position the dust cup over a trash receptacle and slide the **CleanTouch™ Dirt Ejector** slider forward.

REMOVING AND CLEANING THE DUST CUP

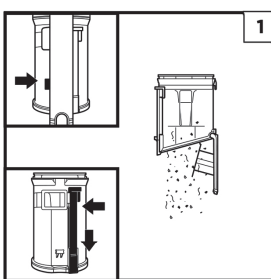

To remove the dust cup from the handheld vacuum, press the **CleanTouch™ Dust Cup Release** button near the handheld vacuum nozzle. Tilt the dust cup and lift off to remove.

To empty dust and debris, hold the dust cup over the trash, then slide the CleanTouch Dirt Ejector slider forward.

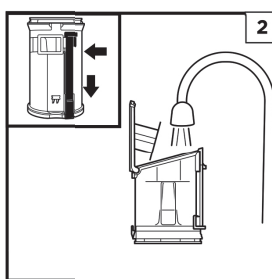

To clean the interior of the dust cup, rinse it with water. Place it on its side with the lid open to air-dry for at least 24 hours before reinstalling.

CLEANING THE FILTERS

Regularly rinse and replace the filters to maintain your vacuum's suction power.

To clean filters, rinse them with water only. Allow all filters to air-dry completely before reinstalling to prevent liquid from being drawn into electric parts. Clean the pre-motor filters at least once a month and post-motor HEPA filter at least once a year. Tap off loose dirt between washes when needed. More frequent cleaning may sometimes be necessary with heavy use.

IMPORTANT: DO NOT use soap when cleaning the filters. Use water only. The vacuum will not have suction if the post-motor HEPA filter is not installed. Ensure that all filters are installed before using.

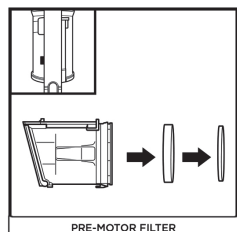

PRE-MOTOR FILTER

Remove the dust cup, and pull the foam and felt filters out of the back of the dust cup.

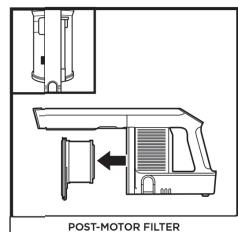

POST-MOTOR FILTER

Remove the dust cup. Pull the post-motor filter out of the handheld vacuum.

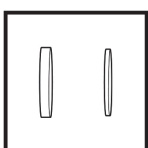

Pre-Motor Foam and Felt Filter Kit

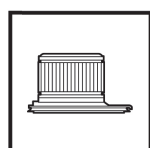

Post-Motor HEPA Filter

Illustrations may differ from actual product. We are constantly striving to improve our products; therefore the specifications contained herein are subject to change without notice.

FLOOR NOZZLE

If any hair is wrapped around the brushroll, continue cleaning using the Carpet setting on a bare floor surface, a low-pile carpet, or a small area rug. If some fibers remain wrapped around the brushroll after continued use, carefully remove them. If you run over a hard or sharp object or notice a change in noise while vacuuming, check the floor nozzle for blockages. (See the Checking for Blockages in the Floor Nozzle section.)

CLEANING SOFT ROLLER

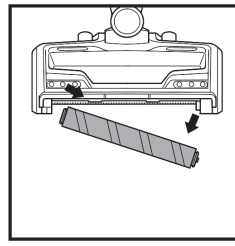

- 1 To remove Soft Roller from nozzle, pull the Soft Roller out by the tab.
- 2 Tap loose debris off the Soft Roller. Use a dry towel to wipe the Soft Roller clean and to remove any debris caught in the teeth behind the Soft Roller.
- 3 Hand wash the Soft Roller as needed. Use only water, and let air-dry completely, which should take at least 24 hours.
- 4 Reinsert Soft Roller until you feel it click into place.

CHECKING FOR BLOCKAGES

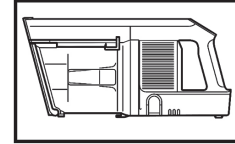

Checking for Blockages in the Handheld Vacuum:

1. Turn off vacuum.
2. Remove the handheld vacuum from the wand.
3. Check all intake openings on the dust cup and remove any debris or blockage.

Checking for Blockages in the Wand:

Standard Wand:

1. Turn off vacuum.
2. Remove the handheld vacuum and floor nozzle.
3. Look through wand to check for any blockages.
4. Clear away debris and blockages.

MultiFLEX® Wand:

1. Turn off vacuum.
2. Remove the handheld vacuum and floor nozzle from the wand.
3. Check the **Clog Access Hose** on the MultiFLEX section of the wand by pinching the tabs on both sides of the hose and lifting the hose out.
4. Clear any debris and blockages.

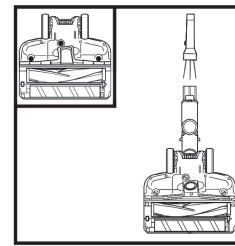

Checking for Blockages in the Floor Nozzle:

1. Turn off vacuum.
2. Detach the wand.
3. Use the edge of a coin to open the three locks on the bottom of the floor nozzle.
4. Remove the cover and tilt back the neck of the floor nozzle.
5. Check the opening and remove any debris.
6. Replace the cover by sliding the inserts into the slots, then pressing down firmly on all sides before turning the locks clockwise to close, until they click securely into place.

TROUBLESHOOTING GUIDE

WARNING: To reduce the risk of shock and unintended operation, turn off power and remove the Lithium Ion Power Pack battery before servicing.

Vacuum is not picking up debris. No suction or light suction. Filter icon on handheld vacuum control panel is red. (Refer to Checking for Blockages section for more information.)

- Check filters to see if they need cleaning. Follow instructions for rinsing and completely air-drying the filters before reinserting in the vacuum.
- Dust cup may be full; empty dust cup.
- Check floor nozzle for blockages; clear blockages if required.
- Remove any string, carpet fibers, or hair that may be wrapped around the brushroll.
- Check clog access in wand for any blockages and clear any debris.
- Check connectors between handheld, wand, and floor nozzle for debris. Remove any dust or material in the connectors.
- If the issue persists, please contact a service center.

Vacuum lifts area rugs.

- Make sure you are not engaging Boost mode as this can be too much suction for lighter rugs. Take care when vacuuming area rugs or rugs with delicately sewn edges.
- Turn off the unit to disengage the brushroll and press the power button to restart.





Brushrolls do not spin.

- Immediately turn off the vacuum. Remove any blockages before turning the vacuum back on. Make sure the handheld vacuum is tilted back far enough for the brushrolls to engage. If the brushrolls still do not spin, please contact a service center.
- If the floor nozzle has headlights and they are not illuminated, there is a connection issue between the handheld vacuum, wand, and nozzle. Try disconnecting and reattaching the pieces. If the headlights still do not illuminate, please contact a service center.

Vacuum turns off on its own.

- There are several possible reasons for the vacuum turning off on its own, including blockages, battery issues, and overheating. If vacuum turns off on its own, perform the following steps:
1. Turn on the vacuum and check the battery indicator lights located on the handheld vacuum. If recharging is needed, make sure power is turned off before connecting to the charger.
 2. Empty dust cup and clean filters (see Emptying the Dust Cup and Cleaning the Filters sections).
 3. Check wand, accessories, and inlet openings and remove any blockages.
 4. Allow unit and battery to cool for at least 45 minutes, until they return to room temperature.
 5. Press power button to restart the vacuum. Make sure the charger is not plugged into the port on the handheld vacuum.

NOTE: If vacuum still does not operate properly, contact a service center.

Part	Fault	Error code display on UI PCBA	Battery Indicator Lights on handheld vacuum are flashing.
Motor	Motor No Start	E2	<ul style="list-style-type: none"> • Bottom LED light is flashing (Fig. A): Battery needs to be charged. • Top and bottom LED lights are flashing (Fig. B): Battery temperature is not optimal, so charging is temporarily paused. Leave battery plugged in and charging will resume soon. • If top 2 or bottom 2 LED lights are flashing (Fig. C, Fig. D), call contact a service center.
	Motor Overheat	E3	
	Motor Overcurrent	E4	
	Motor Short	E5	
	Motor Overspeed	E6	
	System Comm Error	E7	
Nozzle	Nozzle Overheat	F8	   
	Nozzle Short	F1	



8 0 4 1 0 6 7 1 8



PRINTED IN MEXICO / SC: 18-07-2022
 MODEL: IZ640H_B / IZ662H/ Elbrd: J.E.
 / 0.5P / OBPB: N/A

Please be sure to read the enclosed Shark® Owner's Guide prior to using your unit.

QUICK START GUIDE

WHAT'S INSIDE

- (A) Handheld Vacuum
- (B) Motorized Floor Nozzle
- (C) MultiFLEX® Wand
- (D) Pet Multi-tool
- (E) Crevice Tool
- (F) Anti-allergen Dusting Brush
- (G) Li-Ion Charger
- (H) HEPA Post-Motor Filter (Pre-Installed)

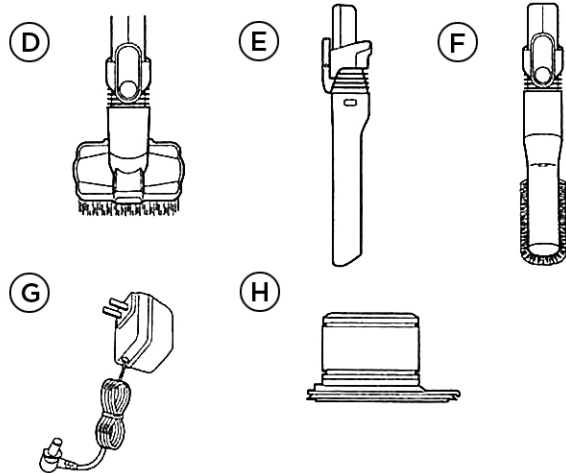

ASSEMBLY

ASSEMBLY

1. Insert **Wand** into **Floor Nozzle**.
2. Insert **Handheld Vacuum** into wand.

For proper operation, ensure all components are completely connected and clicked into place.

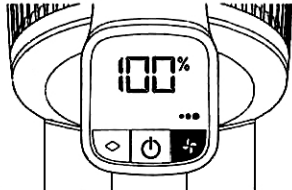
SUCTION POWER MODES	
SUCTION MODE DISPLAY LIGHTS	ECO Mode
○○ Off ●○○ ECO	Maximum runtime. Saves battery power.
●●○ Deep Clean ●●● Boost	Deep Clean Mode
	Best balance between suction power and optimized runtime.
	Boost Mode
	Maximum suction. Uses the most battery power.

NOTE: The Lithium-Ion Power Pack battery comes partially charged. Charge fully before first use, then run the battery down until it is completely out of power. This will condition the battery so the LED indicators will work properly.

