

Shark ROTATOR[®]

LIFT-AWAY[™] ADV

OWNER'S GUIDE

DUO clean POWERFINS

It's important to read this manual prior to using your new product for the first time.



IMPORTANT SAFETY INSTRUCTIONS

FOR HOUSEHOLD USE ONLY • PLEASE READ CAREFULLY BEFORE USE

If the plug does not fit fully into the outlet, reverse the plug. If it still does not fit, contact a qualified electrician. DO NOT force into outlet or try to modify to fit.

⚠ WARNING

To reduce the risk of fire, electric shock, injury, or property damage:

GENERAL WARNINGS

- Your vacuum cleaner may consist of a motorized nozzle, wand, hose, and/or vacuum pod. This device contains electrical connections, electrical wiring, and moving parts that potentially present risk to the user.
- Use only identical replacement parts.
- Carefully observe and follow the instructions provided below to avoid improper use of the appliance. **DO NOT** use the vacuum for any purpose other than those described in this manual.
- Before use, carefully inspect all parts for any damage. **DO NOT** use if any parts are damaged.
- The use of an extension cord is **NOT** recommended.
- This vacuum cleaner contains no serviceable parts.

USE WARNINGS

- This appliance can be used by persons with reduced physical, sensory or mental capabilities or lack of experience and knowledge if they have been given supervision or instruction concerning use of the appliance in a safe way and understand the hazards involved. Cleaning and user maintenance shall not be made by children.
- Keep the appliance and its cord out of reach of children. **DO NOT** allow the appliance to be used by children. **DO NOT** allow to be used as a toy. Close supervision is necessary when used near children.
- Always turn off the vacuum cleaner before connecting or disconnecting any motorized nozzles or other accessories.
- DO NOT** handle plug or vacuum cleaner with wet hands.
- DO NOT** use without filters in place.
- Only use filters and accessories provided
- DO NOT** damage the power cord:
 - DO NOT** pull or carry vacuum cleaner by the cord or use the cord as a handle.
 - DO NOT** unplug by pulling on cord. Grasp the plug, not the cord.
 - DO NOT** run the vacuum cleaner over the power cord, close a door on the cord, pull the cord around sharp corners, or leave the cord near heated surfaces.
- DO NOT** put any objects into nozzle or accessory openings. **DO NOT** use with any opening blocked; keep free of dust, lint, hair, and anything that may reduce airflow.
- DO NOT** use if nozzle or accessory airflow is restricted. If the air paths or the motorized floor nozzle become blocked, turn the vacuum cleaner off and unplug from electrical outlet. Remove all obstructions before you plug in and turn on the unit again.
- Keep nozzle and all vacuum openings away from hair, face, fingers, uncovered feet, or loose clothing.
- DO NOT** use if vacuum cleaner is not working as it should, or has been dropped, damaged, left outdoors, or dropped into water.

- Use extra care when cleaning on stairs.
- DO NOT** leave the vacuum cleaner unattended while plugged in.
- When powered on, keep the vacuum cleaner moving over the carpet surface at all times to avoid damaging the carpet fibers.
- DO NOT** place vacuum cleaner on unstable surfaces such as chairs or tables.
- Your Shark[®] vacuum may not be designed to stand up on its own. When taking a break from cleaning, you may need to lean it against furniture or a wall, or lay it flat on the floor. Using the vacuum for an application where the unit lacks stability may result in personal injury.
- DO NOT** use to pick up:
 - Liquids
 - Large objects
 - Hard or sharp objects (glass, nails, screws, or coins)
 - Large quantities of dust (drywall dust, fireplace ash, or embers). **DO NOT** use as an attachment to power tools for dust collection.
 - Smoking or burning objects (hot coals, cigarette butts, or matches)
 - Flammable or combustible materials (lighter fluid, gasoline, or kerosene)
 - Toxic materials (chlorine bleach, ammonia, or drain cleaner)
- DO NOT** use in the following areas:
 - Poorly lit areas
 - Wet or damp surfaces
 - Outdoor areas
 - Spaces that are enclosed and may contain explosive or toxic fumes or vapors (lighter fluid, gasoline, kerosene, paint, paint thinners, mothproofing substances, or flammable dust)
- Turn off all controls before plugging in or unplugging the vacuum.
- Unplug from electrical outlet when not in use and before any maintenance or cleaning.
- Hand wash with water only. Washing with cleaning chemicals could damage the unit.
- During cleaning or routine maintenance, **DO NOT** cut anything other than hair, fibers, or string wrapped around the brushroll.
- Allow all filters to air-dry completely before replacing in the vacuum to prevent liquid from being drawn into electric parts.
- Make sure the dust cup and all filters are in place after routine maintenance.
- If provided, secure the power cord around the two cord hooks during storage.

TECHNICAL SPECIFICATIONS

Voltage: 120V~, 60Hz

ASSEMBLY

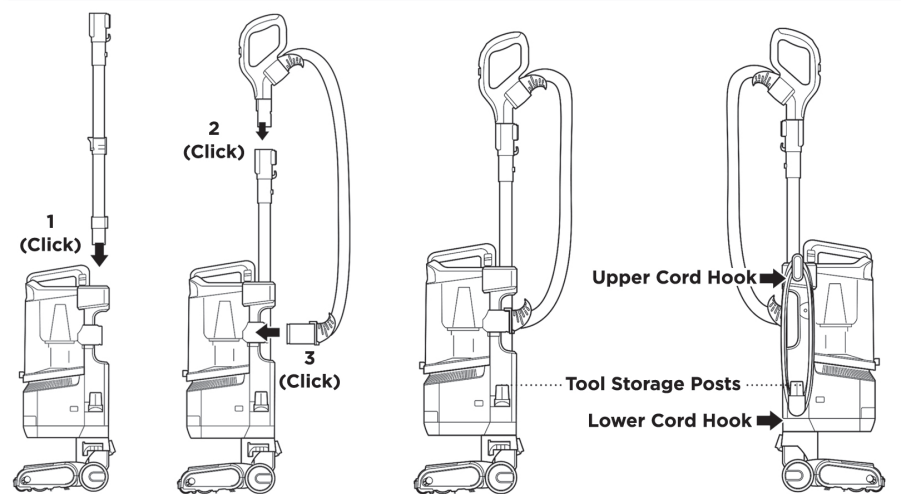

- Insert **Wand** into pod
- Insert **Handle** into wand.
- Attach **Hose** to back of vacuum pod.

For proper operation, ensure all parts are firmly clicked into place.

NOTE: Accessories may vary depending on the model. Refer to quick guide, if available. The images shown here are for illustrative purposes only and may be subject to change.

POWER CORD

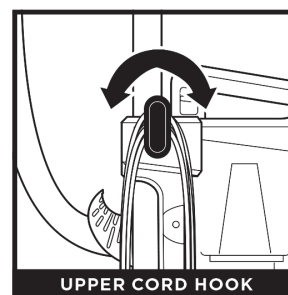

For cord access, rotate upper hook down and remove cord.

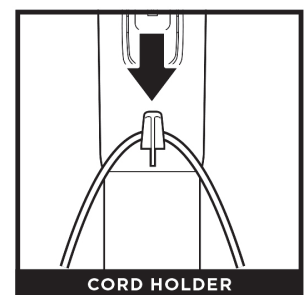

Use cord holder on the side of wand to hold cord in place while vacuuming.

WHOLE-HOME CLEANING

SETTINGS

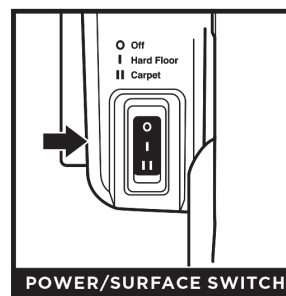

Select surface setting:

- O Power Off**
- I Hard Floor**
For hard floors and small area rugs.
- II Carpet**
For carpets.

NOTE: Brushroll spins in all modes

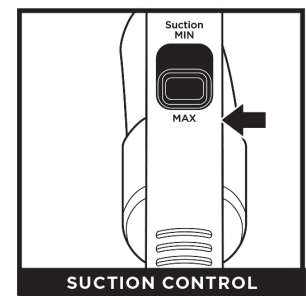

The **Suction Control Slider** located on the handle allows you to adjust the suction depending on the floor type.

- MIN:** to reduce suction and increase maneuverability on carpets.
- MAX:** to increase suction on hard floors.

BRUSHROLL INDICATOR LIGHT

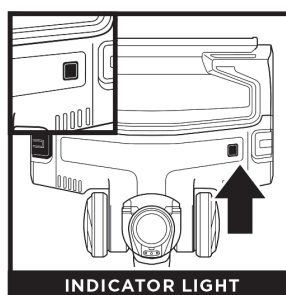

WHAT DOES THE BRUSHROLL INDICATOR LIGHT MEAN?

- Solid Green:** The brushroll is spinning and working as intended.
- Solid Red:** There is a jam in the brushroll area. Turn off and unplug the vacuum and remove any blockages in the nozzle.
- Flashing Red:** The motorized floor nozzle is overheating. Turn off the vacuum, unplug it, and remove any blockages. Let the vacuum cool down for at least 60 minutes before restarting. See Troubleshooting section for more information.

NOTE: For deep carpet cleaning per ASTM F608, use setting II (Carpet) with max suction.

WHOLE-HOME CLEANING

CLEANING MODES

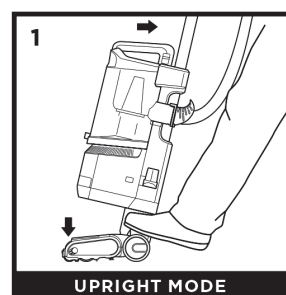

UPRIGHT MODE

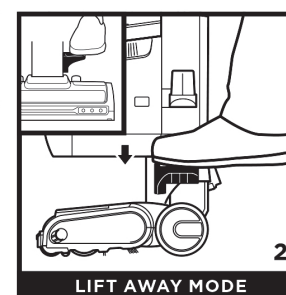

LIFT AWAY MODE



ABOVE-FLOOR-HANDLE

- To engage **Brushroll**, step on floor nozzle and tilt handle back firmly.
- Step on the pedal on the floor nozzle to lift off the pod.
- Press the **Handle Release** button and pull up on the handle to detach it from the wand.

To reduce the risk of electric shock, this appliance has a polarized plug (one blade is wider than the other). This plug will fit in a polarized outlet only one way. If the plug does not fit fully in the outlet, reverse the plug. If it still does not fit, contact a qualified electrician to install the proper outlet. Do not change the plug in any way.

SAVE THESE INSTRUCTIONS

CLEANING MODES - Cont.

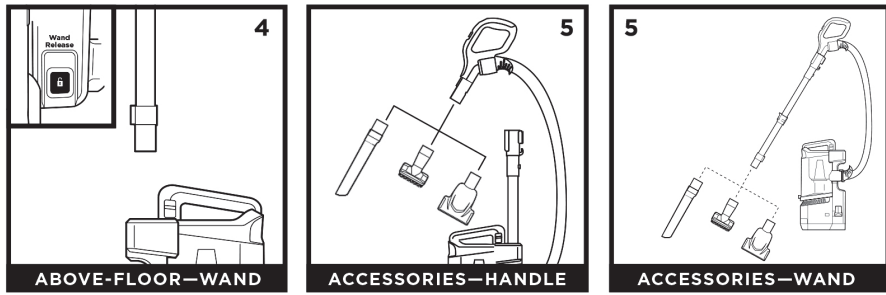

4. Press the **Wand Release** button and pull up on the wand to detach it from the pod.
5. Attach an optional cleaning accessory to handle or wand.

NOTE: All accessories are compatible with both the wand and the handle. Included accessories will vary by model.

EMPTYING THE DUST CUP

IMPORTANT: Unplug the power cord before performing any maintenance.

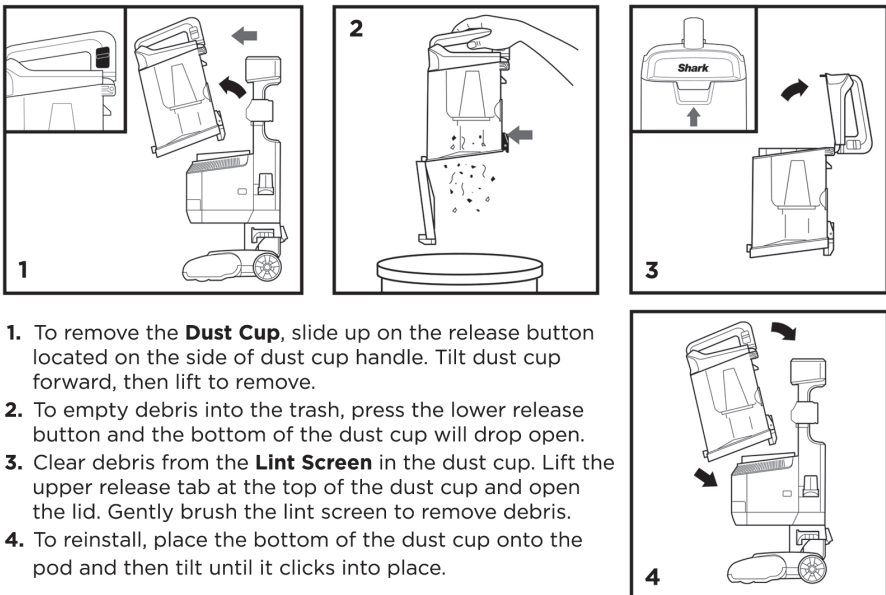

1. To remove the **Dust Cup**, slide up on the release button located on the side of dust cup handle. Tilt dust cup forward, then lift to remove.
2. To empty debris into the trash, press the lower release button and the bottom of the dust cup will drop open.
3. Clear debris from the **Lint Screen** in the dust cup. Lift the upper release tab at the top of the dust cup and open the lid. Gently brush the lint screen to remove debris.
4. To reinstall, place the bottom of the dust cup onto the pod and then tilt until it clicks into place.

CLEANING THE FILTERS

Regularly rinse the filters to maintain your vacuum's suction power.

Rinse filters with cold water only. Allow all filters to air-dry for at least 24 hours before reinstalling them to prevent liquid from being drawn into electronic parts.

IMPORTANT: DO NOT use soap when cleaning the filters

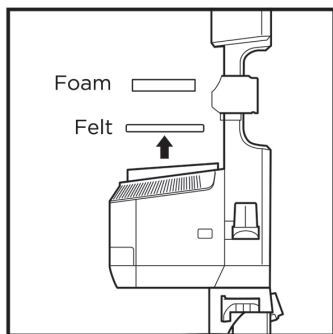

RINSE PRE-MOTOR FILTERS EVERY MONTH

Remove the **Dust Cup**, then lift out **Filters**.

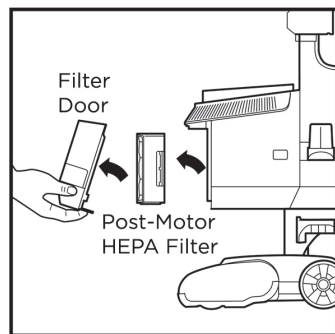

RINSE HEPA FILTER EVERY YEAR

To remove the **HEPA Filter**, first pull the tab on the bottom of the filter door, then lift off the door. Press the tab on the side of the HEPA filter and pull out the filter. To reinstall the door, align the top first, then press in the bottom until it clicks into place.

MAINTENANCE

NOZZLE MAINTENANCE

SELF-CLEANING BRUSHROLL

If any hair is wrapped around the brushroll, continue vacuuming, using Carpet/Low Pile mode on a bare floor surface, a low-pile carpet, or a small area rug. This will allow the self-cleaning brushroll to remove the hair wrap and send it to the dust cup.

If you run over a hard or sharp object or notice a noise change while vacuuming, check for blockages or objects caught in the brushroll.

If some fibers remain wrapped around the brushroll after continued use, carefully remove them.

CLEANING THE SOFT ROLLER

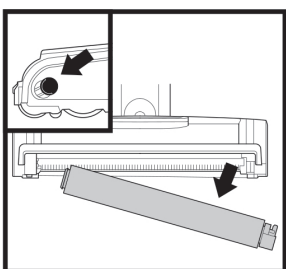

Slide the Soft Roller access button forward to release the Soft Roller.

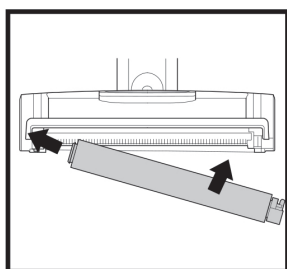

Hand wash the Soft Roller as needed. Use only water, and allow it to air-dry completely for at least 24 hours. Reinsert the Soft Roller in the front of the nozzle until it clicks into place.

CHECKING FOR BLOCKAGES

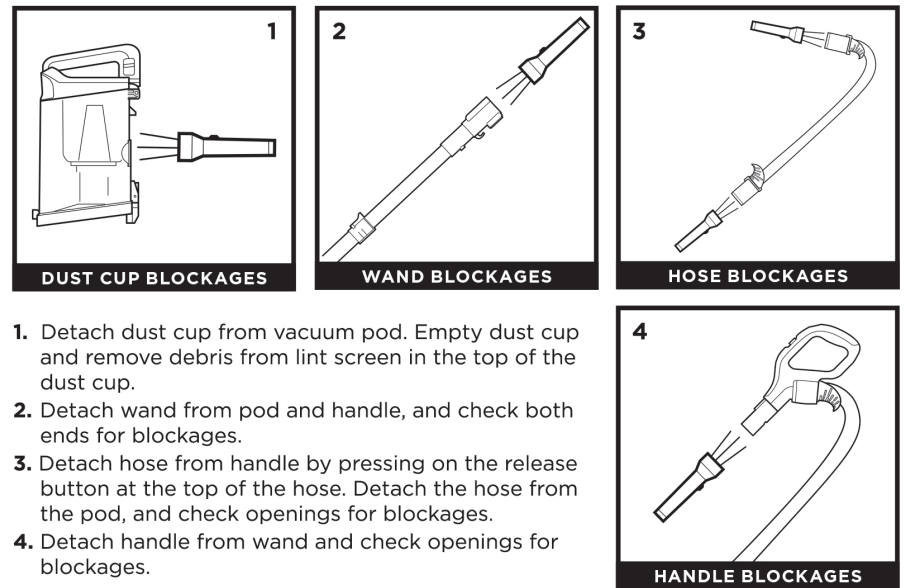

1. Detach dust cup from vacuum pod. Empty dust cup and remove debris from lint screen in the top of the dust cup.
2. Detach wand from pod and handle, and check both ends for blockages.
3. Detach hose from handle by pressing on the release button at the top of the hose. Detach the hose from the pod, and check openings for blockages.
4. Detach handle from wand and check openings for blockages.

TROUBLESHOOTING

Vacuum is not picking up debris. No suction or light suction.

- Check filters to see if they need cleaning. Follow instructions for rinsing and air-drying the filters before reinstalling them in the vacuum.
- Dust cup may be full; empty dust cup.
- Check handle, hose, hose connections, nozzle, wand, pod, and accessories for blockages. Clear any blockages found.
- If any string, hair, or carpet fibers are wrapped around the brushroll, carefully cut debris with scissors and remove from brushroll. See Nozzle Maintenance section for more information.

Vacuum lifts area rugs.

- Make sure Power/Surface switch is set to Hard Floor (setting I).
- Ensure the suction control slider on the handle is set to MIN.
- Suction is powerful. Take care when vacuuming area rugs or rugs with delicately sewn edges.

Brushroll does not spin in carpet cleaning mode.

- If the brushroll indicator light turns red, immediately turn off and unplug the vacuum. Remove pod from floor nozzle and clear any blockages. Reconnect nozzle, plug in vacuum, and turn on power.
- With the power on, recline the handle, which will automatically turn on the brushroll.
- If this problem persists on thick carpets, move the suction control slider to MIN.

Vacuum turns off on its own or indicator light flashes red.

If your vacuum overheats, the thermostat will automatically turn the suction motor off.

Perform the following steps to restart the thermostat:

1. Turn vacuum off and unplug it.
2. Empty dust cup and clean filters (see Emptying the Dust Cup and Cleaning the Filters).
3. Check for blockages in hose, wand, nozzle, accessories, and inlet openings.
4. Allow unit to cool for a minimum of 60 minutes.
5. Plug in vacuum and restart with the Power/Surface switch.

For all other issues, please contact a service center.



PRINTED IN MEXICO
OBPN: LA500Series_IB_E_F_S_MP_Mv1
SC: 04-27-2021_TAB
Elbrd: Y.T.
MODEL: LA502_B



Please be sure to read the enclosed Shark® Owner's Guide prior to using your unit.

Shark

QUICK START GUIDE

WHAT'S INSIDE

A Handle & Hose

B Wand

C Vacuum Pod

D Floor Nozzle

E Crevice Tool

F Dusting Brush

G Pet Power Brush

NOTE: The images shown here are for illustrative purpose only and may vary.

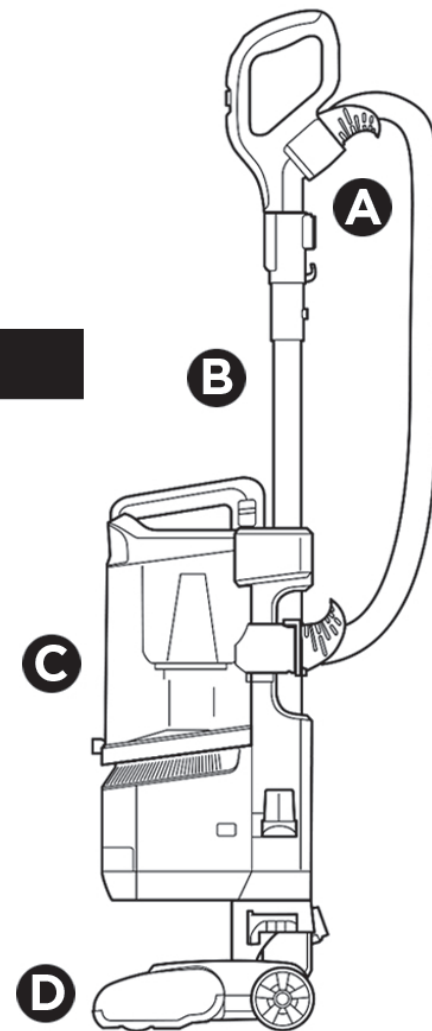
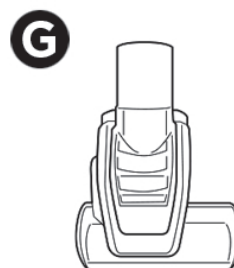
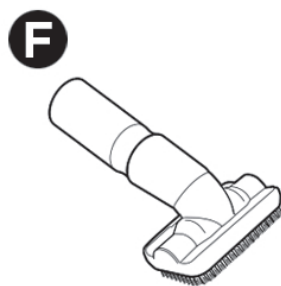
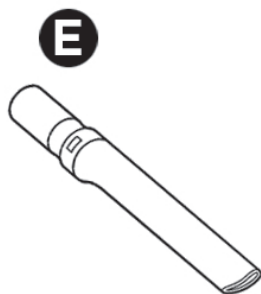

Elbrd: Y.T.

OBPN: BxFlp

804006409

SC: 04-29-2021_5P

PRINTED IN MEXICO

MODEL: LA322_B