

Shark Navigator® Swivel Pro Complete Upright Vacuum

NV150 Series

Owner's Manual

804109767

IMPORTANT SAFETY INSTRUCTIONS

FOR HOUSEHOLD USE ONLY • PLEASE READ CAREFULLY BEFORE USE
If the plug does not fit fully into the outlet, reverse the plug. If it still does not fit, contact a qualified electrician. DO NOT force into outlet or try to modify to fit.

WARNING

To reduce the risk of fire, electric shock, injury, or property damage:

GENERAL WARNINGS

- Your vacuum cleaner may consist of a motorized nozzle, wand, hose, and/or vacuum pod. This device contains electrical connections, electrical wiring, and moving parts that potentially present risk to the user.
- Use only identical replacement parts.
- Carefully observe and follow the instructions provided below to avoid improper use of the appliance. **DO NOT** use the vacuum for any purpose other than those described in this manual.
- Before use, carefully inspect all parts for any damage. **DO NOT** use if any parts are damaged.
- The use of an extension cord is **NOT** recommended.
- This vacuum cleaner contains no serviceable parts.

USE WARNINGS

- This appliance can be used by persons with reduced physical, sensory or mental capabilities or lack of experience and knowledge if they have been given supervision or instruction concerning use of the appliance in a safe way and understand the hazards involved. Cleaning and user maintenance shall not be made by children.
- Keep the appliance and its cord out of reach of children. **DO NOT** allow the appliance to be used by children. **DO NOT** allow to be used as a toy. Close supervision is necessary when used near children.
- Always turn off the vacuum cleaner before connecting or disconnecting any motorized nozzles or other accessories.
- DO NOT** handle plug or vacuum cleaner with wet hands.
- DO NOT** use without filters in place.
- Only use filters provided with this unit. Failure to do so will also void the warranty.
- DO NOT** damage the power cord:
 - DO NOT** pull or carry vacuum cleaner by the cord or use the cord as a handle.
 - DO NOT** unplug by pulling on cord. Grasp the plug, not the cord.
 - DO NOT** run the vacuum cleaner over the power cord, close a door on the cord, pull the cord around sharp corners, or leave the cord near heated surfaces.
- DO NOT** put any objects into nozzle or accessory openings. **DO NOT** use with any opening blocked; keep free of dust, lint, hair, and anything that may reduce airflow.
- DO NOT** use if nozzle or accessory airflow is restricted. If the air paths or the motorized floor nozzle become blocked, turn the vacuum cleaner off and unplug from electrical outlet. Remove all obstructions before you plug in and turn on the unit again.
- Keep nozzle and all vacuum openings away from hair, face, fingers, uncovered feet, or loose clothing.
- DO NOT** use if vacuum cleaner is not working as it should, or has been dropped, damaged, left outdoors, or dropped into water.
- Use extra care when cleaning on stairs.
- DO NOT** leave the vacuum cleaner unattended while plugged in.
- When powered on, keep the vacuum cleaner moving over the carpet surface at all times to avoid damaging the carpet fibers.
- DO NOT** place vacuum cleaner on unstable surfaces such as chairs or tables.
- Your Shark® vacuum may not be designed to stand up on its own. When taking a break from cleaning, you may need to lean it against furniture or a wall, or lay it flat on the floor. Using the vacuum for an application where the unit lacks stability may result in personal injury.
- DO NOT** use to pick up:
 - Liquids
 - Large objects
 - Hard or sharp objects (glass, nails, screws, or coins)
 - Large quantities of dust (drywall dust, fireplace ash, or embers). **DO NOT** use as an attachment to power tools for dust collection.
 - Smoking or burning objects (hot coals, cigarette butts, or matches)
 - Flammable or combustible materials (lighter fluid, gasoline, or kerosene)
 - Toxic materials (chlorine bleach, ammonia, or drain cleaner)
- DO NOT** use in the following areas:
 - Poorly lit areas
 - Wet or damp surfaces
 - Outdoor areas
 - Spaces that are enclosed and may contain explosive or toxic fumes or vapors (lighter fluid, gasoline, kerosene, paint, paint thinners, mothproofing substances, or flammable dust)
- Turn off all controls before plugging in or unplugging the vacuum.
- Unplug from electrical outlet when not in use and before any maintenance or cleaning.
- Hand wash with water only. Washing with cleaning chemicals could damage the unit.
- During cleaning or routine maintenance, **DO NOT** cut anything other than hair, fibers, or string wrapped around the brushroll.
- Allow all filters to air-dry completely before replacing in the vacuum to prevent liquid from being drawn into electric parts.
- Make sure the dust cup and all filters are in place after routine maintenance.
- If provided, secure the power cord around the two cord hooks during storage.

To reduce the risk of electric shock, this appliance has a polarized plug (one blade is wider than the other). This plug will fit in a polarized outlet only one way. If the plug does not fit fully in the outlet, reverse the plug. If it still does not fit, contact a qualified electrician to install the proper outlet. Do not change the plug in any way.

SAVE THESE INSTRUCTIONS

“NOTE:

Accessories may vary depending on the model. Refer to quick guide, if available. The images shown here are for illustrative purposes only and may be subject to change.”

ASSEMBLY

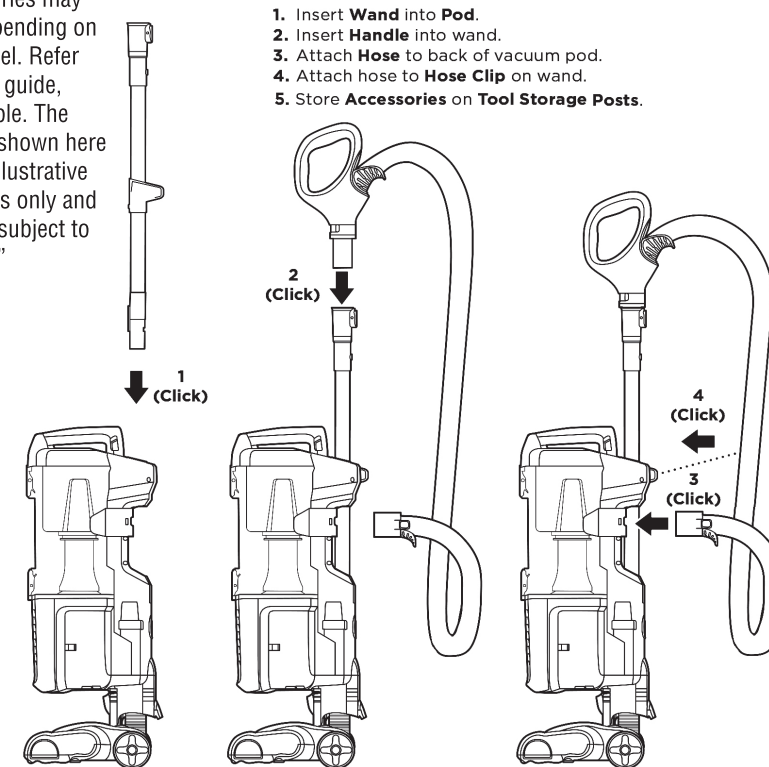

For proper operation, ensure all parts are firmly clicked into place.

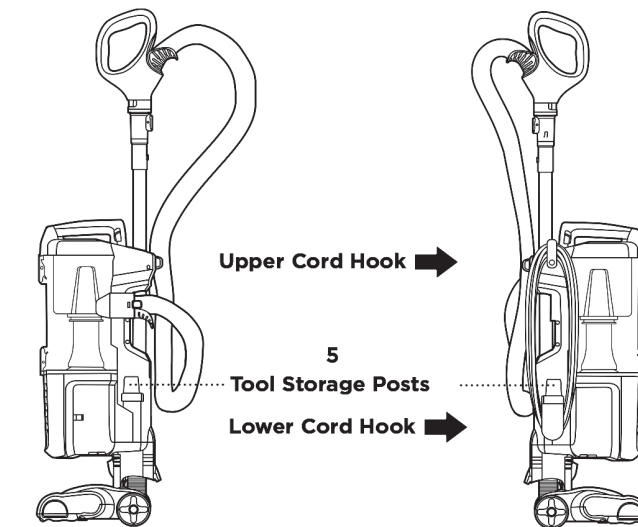

POWER CORD

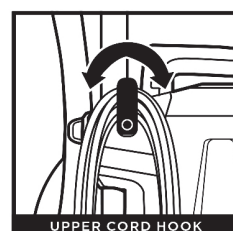

For cord access, rotate upper hook down and remove cord.

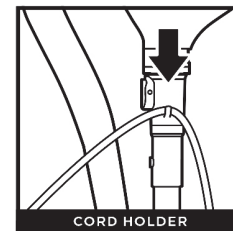

Use cord holder on the side of wand to hold cord in place while vacuuming.

WHOLE-HOME CLEANING

SETTINGS

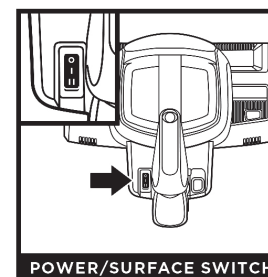

Select surface setting:

- 0 Power Off**
- I Hard Floor**
For bare floors and small area rugs.
- II Carpet**
For carpets.

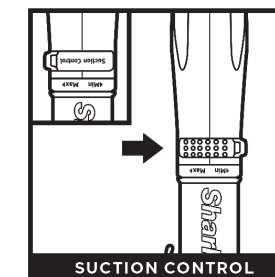

The **Suction Control Slider** located on the top of the handle allows you to adjust the suction depending on the floor type.
MIN: to reduce suction and increase maneuverability on carpets.
MAX: to increase suction on bare floors.

BRUSHROLL INDICATOR LIGHT

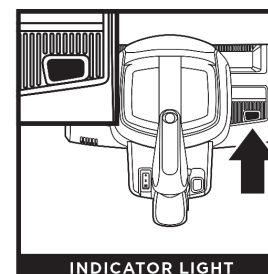

WHAT DOES THE BRUSHROLL INDICATOR LIGHT MEAN?

- Solid Green:** The brushroll is spinning and working as intended.
- Solid Red:** There is a jam in the brushroll area. Turn off and unplug the vacuum and remove any blockages in the nozzle.
- Flashing Red:** The motorized floor nozzle is overheating. Turn the vacuum off and wait a minimum of 45 minutes for the unit to cool down.

Note: For deep carpet cleaning per ASTM F608 (embedded dirt in carpets), set to MAX suction and use setting II, Carpet

CLEANING MODES



To engage **Brushroll**, place foot on floor nozzle and tilt handle back firmly.

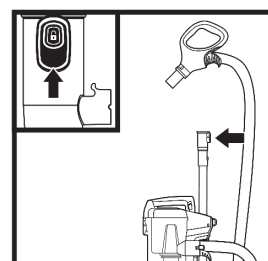

Press the **Handle Release** button and pull up on the handle to detach it from the wand.

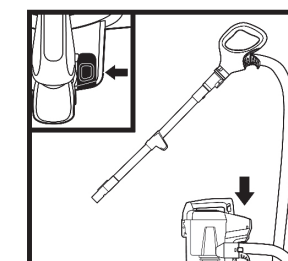

Press the **Wand Release** button and pull up on the wand to detach it from the pod.

EMPTYING THE DUST CUP

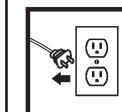

IMPORTANT: Unplug the power cord before performing any maintenance.

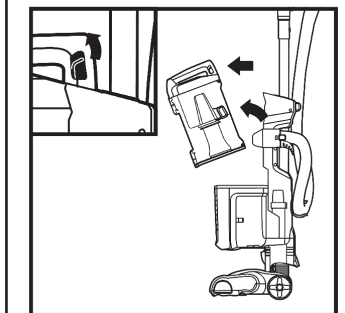

To remove **Dust Cup**, pull up on the dust cup release button located on the top of dust cup handle. Tilt dust cup forward, then lift to remove.

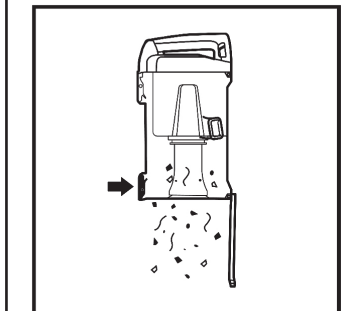

Press the release button to open bottom of dust cup.

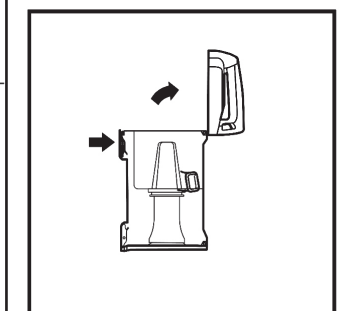

To remove collected debris from **Lint Screen**, press the top release button and lift the handle to open the dust cup. Gently brush lint screen to clean.

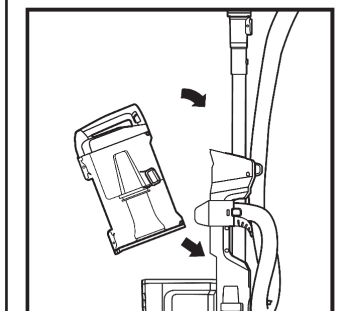

To reinstall, place the bottom of dust cup onto the pod and then tilt until it clicks into place.

CLEANING AND REPLACING THE FILTERS

CLEANING FILTERS

Regularly rinse and replace the filters to maintain your vacuum's suction power.

To rinse filters, use cold water only to prevent damage from cleaning chemicals. Allow all filters to air-dry for at least 24 hours before reinstalling them to prevent liquid from being drawn into electronic parts.

IMPORTANT: DO NOT use soap when cleaning the filters.

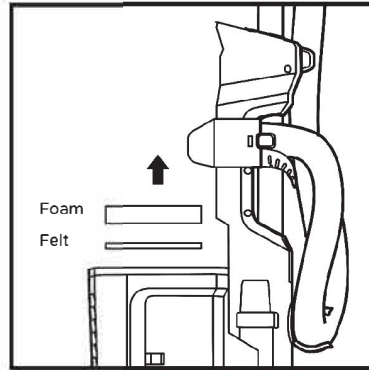

RINSE PRE-MOTOR FILTERS EVERY MONTH

Remove **Dust Cup**, then lift out **Filters**.

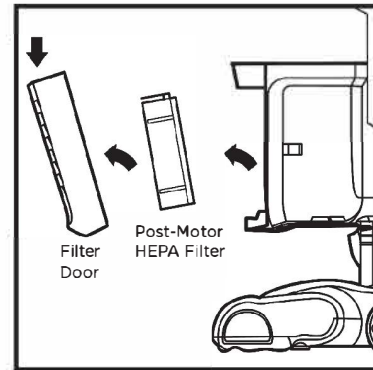

RINSE HEPA FILTER EVERY YEAR

Tilt **Filter Door** and firmly pull it off. Press tab at top of **HEPA Filter** and pull out filter. To reinstall, insert HEPA filter into unit and replace the filter door.

MAINTENANCE

CLEANING THE BRUSHROLL

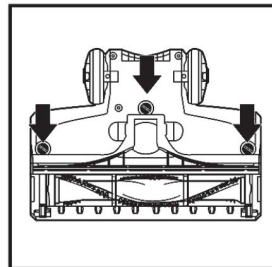

Using a coin, turn locks counterclockwise, then lift the cover to access brushroll.

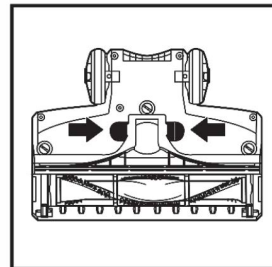

DEBRIS BEHIND BRUSHROLL

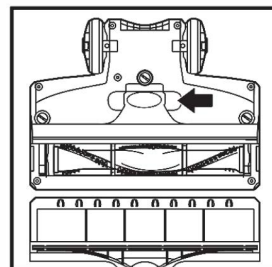

If you run over a hard or sharp object or notice a noise change while vacuuming, check for blockages or objects caught behind the brushroll.

Clear away any dust, dirt, or blockages in **Debris Intake**.

To close the cover, push down until it clicks into place. Close the locks by using a coin to turn them clockwise.

Note: The images shown here are for illustrative purposes only and may be subject to change.

CHECKING FOR BLOCKAGES

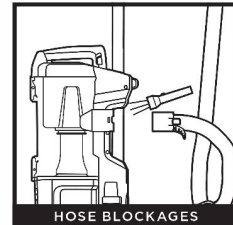

Detach hose from vacuum pod, and check hose and opening on back of pod for blockages.

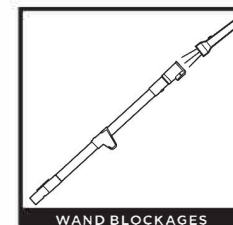

Detach wand from pod and handle, and check both ends for blockages.

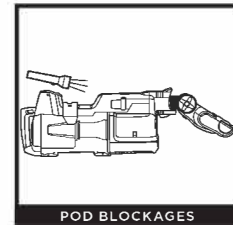

Detach wand from pod, and check opening for blockages.

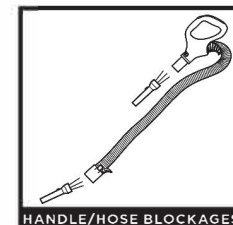

Detach handle from wand and hose from the vacuum pod, and check openings for blockages.



Detach dust cup from vacuum pod. Empty dust cup, remove debris from lint screen, and check for blockages.

Note: The image shown here is for illustrative purposes only and may be subject to change. The actual number of accessories may vary depending on the model.

TROUBLESHOOTING

Vacuum is not picking up debris. No suction or light suction.

- Check filters to see if they need cleaning. Follow instructions for rinsing and air-drying the filters before reinserting in the vacuum.
- Dust cup may be full; empty dust cup.
- Check hose, hose connections, nozzle, wand, pod, and accessories for blockages. Clear any blockages found.
- If any string, hair, or carpet fibers are wrapped around the brushroll, remove the floor nozzle cover and carefully cut debris with scissors and remove from brushroll. See Cleaning the Brushroll section for more information.

Vacuum lifts area rugs.

- Make sure Power/Surface switch is set to Hard Floor (setting I).
- Rotate suction control slider to MIN.
- Suction is powerful. Take care when vacuuming area rugs or rugs with delicately sewn edges.

Brushroll does not spin in carpet cleaning mode.

- If the Brushroll Indicator Light turns red, immediately turn off and unplug the vacuum. Remove pod from floor nozzle and clear any blockages. Reconnect nozzle, plug in vacuum, and turn on power.
- With the power on, recline the handle, which will automatically turn on the brushroll.
- Ensure that the Power/Surface switch is set to Carpet (setting II) for brushroll to spin.

Vacuum turns off on its own or indicator light flashes red.

This vacuum is equipped with a motor-protective thermostat. If your vacuum overheats, the thermostat will automatically turn the suction motor off. Perform the following steps to restart the thermostat:

1. Turn vacuum off and unplug it.
2. Empty dust cup and clean filters (see Emptying the Dust Cup and Cleaning the Filters).
3. Check for blockages in hose, accessories, and inlet openings.
4. Allow unit to cool for a minimum of 45 minutes.
5. Plug in vacuum and restart with the Power/Surface switch.

TECHNICAL SPECIFICATIONS

Voltage: 120V, 60Hz
Amps: 5.8A

Printed in Mexico
Sc: 02.26.2020
Pgs.:TAB
Obpn:NV150Series_IB_MP_Mv2_190614
Shnmdl: NV150_BP
elbrd:i.a.

804109767



Please be sure to read the enclosed Shark® Owner's Guide prior to using your unit.

Shark Navigator™

SWIVEL PRO COMPLETE

NV150

QUICK START GUIDE

WHAT'S INSIDE

- A Vacuum Pod
- B Handle & Hose
- C Wand
- D Crevice Tool
- E Upholstery Tool

ASSEMBLY

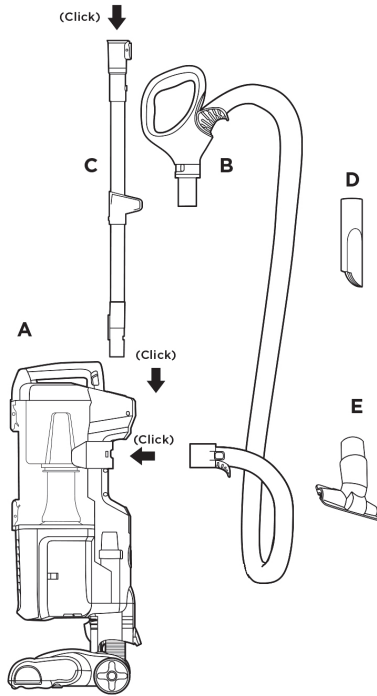

NOTE: For proper operation, ensure all parts are firmly CLICKED into place.

EMPTYING THE DUST CUP

Empty the dust cup after each use.

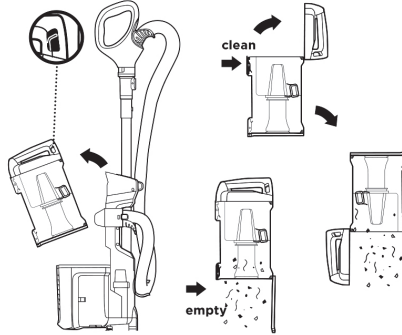

MAINTENANCE

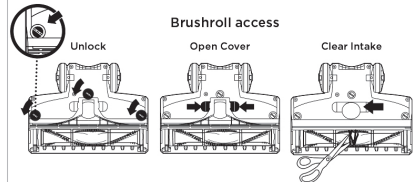
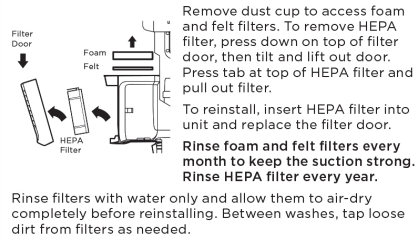

Use a coin to turn the locks counterclockwise until they click open, then lift the cover to access the brushroll. Clear the debris intake.

2 WAYS TO CLEAN

FLOOR CLEANING

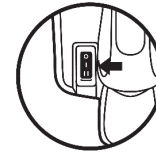

- 1 **HARD FLOOR**
Press switch to I for hard floor surfaces.

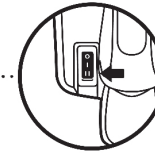

- 2 **CARPET**
Press switch to II for low and high pile carpet cleaning.

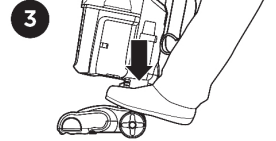

To engage brushroll, step on floor nozzle and tilt handle back.

ABOVE-FLOOR CLEANING

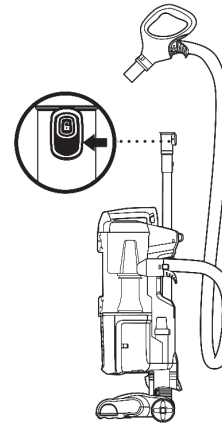

- 1 To clean above-floor areas, remove the handle from the wand. Or for more reach, remove the wand from the pod.

OR

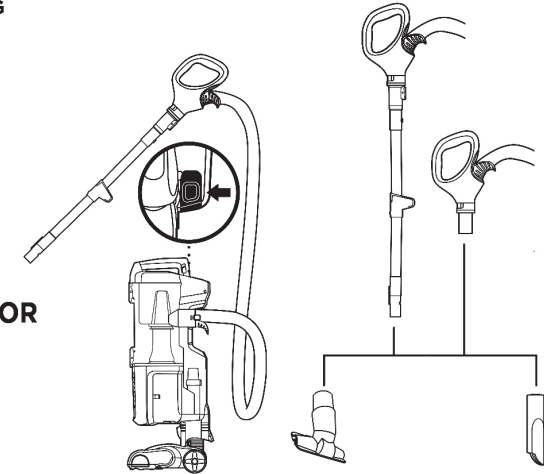

- 2 Attach a cleaning accessory to handle or wand.

Accessory type and quantity may vary depending on the model.

Accessory type and quantity may vary depending on the model. The images shown here are for illustrative purposes only and may be subject to change.

804009767A

Printed in Mexico
Sc: 02.27.2020/Pgs.:1/Obpn:NV150_QSG_MP_
Mv1_190610/Shmmdl: NV150_E2GB_BP - elbrd:i.a.

804009767A

