

# Shark ROTATOR®

## NV500 Series INSTRUCTIONS

PLEASE READ CAREFULLY AND KEEP FOR FUTURE REFERENCE.  
This Owner's Guide is desing to help you get a complete unertanding of your new Sharrk Rotator Professional Lift-Away.

804108928

### IMPORTANT SAFETY INSTRUCTIONS FOR HOUSEHOLD USE ONLY

#### ⚠ WARNING

To reduce the risk of injury, fire, electric shock, and property damage resulting from improper use of the appliance, carefully observe the following instructions. This unit contains electrical connections and moving parts that potentially present risk to the user.

#### THE POWER NOZZLE, WAND, AND HANDLE CONTAIN ELECTRICAL CONNECTIONS:

- These are not serviceable parts.
- Do not use to vacuum any liquids.
- Do not immerse in water.
- If handle/wand is damaged, discontinue use.

1 Inspect power cord and plug for any damage before use. DO NOT use vacuum cleaner with a damaged cord or plug. Turn off all controls before plugging in or unplugging the vacuum cleaner. Store your vacuum cleaner with the power cord secured around the two cord hooks.

2 DO NOT use outdoors or on wet surfaces. Use only on dry surfaces.

3 Unplug from electrical outlet when not in use and before servicing.

4 If vacuum cleaner is not working as it should, or has been dropped, damaged, left outdoors, or dropped into water, call a sevice center.

5 The hose contains electrical wires. DO NOT use when damaged, cut, or punctured.

6 DO NOT pull or carry vacuum cleaner by the cord or use the cord as a handle.

7 DO NOT unplug by pulling on cord. Grasp the plug, not the cord.

8 DO NOT handle plug or vacuum cleaner with wet hands.

9 DO NOT run the vacuum cleaner over the power cord, close a door on the cord, or pull the cord around sharp corners.

10 The use of an extension cord is NOT recommended.

11 DO NOT leave vacuum cleaner unattended when plugged in.

12 Keep cord away from heated surfaces.

13 Always turn off the vacuum cleaner before connecting or disconnecting motorized nozzle.

#### GENERAL USE

14 Use only as described in this manual.

15 Keep your work area well lit.

16 Keep the vacuum cleaner moving over the carpet surface at all times to avoid damaging the carpet fibers.

17 DO NOT place vacuum cleaner on unstable surfaces such as chairs or tables.

18 DO NOT put any objects into openings. DO NOT use with any opening blocked; keep free of dust, lint, hair, and anything that may reduce airflow.

19 DO NOT allow the appliance to be used by children. Close attention is necessary when used near children. This is not a toy.

20 DO NOT use without dust cup and/or filters in place.

#### DUST CUP/FILTERS/ACCESSORIES

Before turning on the vacuum:

21 Make sure that all filters are thoroughly dry after routine cleaning.

22 Make sure that dust cup and all filters are in place after routine maintenance.

23 Make sure accessories are free of blockages.

24 Only use Shark®-brand filters and accessories (failure to do so will void the warranty).

#### HOSE ATTACHMENTS

25 DO NOT use if airflow is restricted. If the air paths or the motorized floor nozzle become blocked, turn the vacuum cleaner off and unplug from electrical outlet. Remove all obstructions before you turn on the unit again.

26 Keep the end of the hose and accessory openings away from face and body.

27 Keep cleaning tools and hose suction openings away from hair, face, fingers, uncovered feet, or loose clothing.

28 Only use manufacturer's recommended attachments.

#### GENERAL CLEANING

29 DO NOT vacuum up large objects.

30 DO NOT vacuum up hard or sharp objects such as glass, nails, screws, or coins that could damage the vacuum cleaner.

31 DO NOT vacuum up drywall dust, fireplace ash, or embers. DO NOT use as an attachment to power tools for dust collection.

32 DO NOT vacuum up smoking or burning objects such as hot coals, cigarette butts, or matches.

33 DO NOT vacuum up flammable or combustible materials (e.g., lighter fluid, gasoline, or kerosene) or use vacuum in areas where they may be present.

34 DO NOT vacuum up toxic solutions (e.g., chlorine bleach, ammonia, or drain cleaner).

35 DO NOT use in an enclosed space where vapors are present from paint, paint thinner, moth-proofing substances, flammable dust, or other explosive or toxic materials.

36 DO NOT vacuum up any liquids.

37 DO NOT immerse vacuum cleaner in water or other liquids.

38 Use extra care when cleaning on stairs.

### GETTING TO KNOW YOUR SHARK® ROTATOR® PROFESSIONAL LIFT-AWAY®

#### WELCOME!

Congratulations on your purchase. Use this instruction manual to learn about your new vacuum's great features. From assembly to use to maintenance, you will find it all in here.

#### MAIN UNIT

- A Hose
- B Suction Control
- C Handle Release Button
- D Upper Cord Hook
- E Power Button
- F Lift-Away® Button
- G Brushroll on/off button
- H Wand Release Button
- I Wand
- J Lower Cord Hook
- K Motorized Floor Nozzle
- L Brushroll Indicator Light
- M Headlights

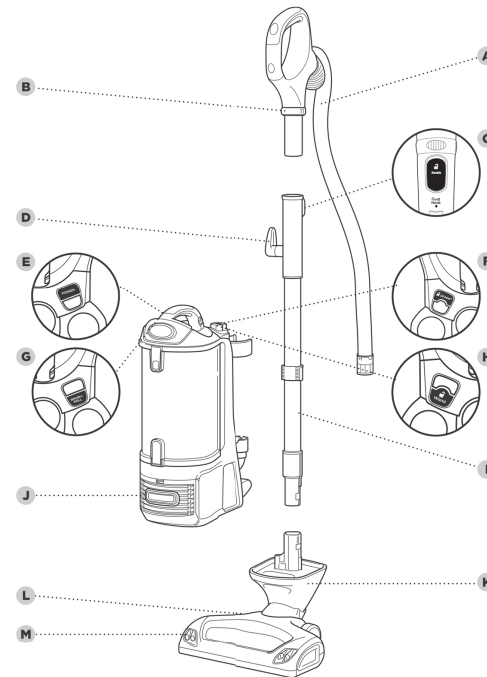

Note:  
Your Quick Start Guide shows the accessories that are included with your model.

\*Accessories may vary depending on model.

The image shown here is for illustrative purposes only and may be subject to change.

### ASSEMBLING YOUR VACUUM

⚡ **TIP:** For quick cord access, rotate upper hook down and remove cord.

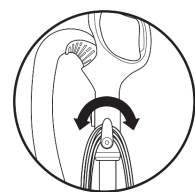

⚡ **TIP:** To store your vacuum, wrap cord around cord hooks.

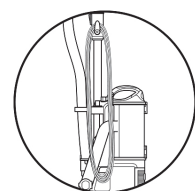

⚡ **TIP:** Use cord clip located on the back of wand to hold cord in place while vacuuming.

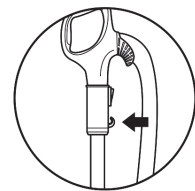

#### STEP 1



1 Place the pod onto floor nozzle.

#### STEP 2

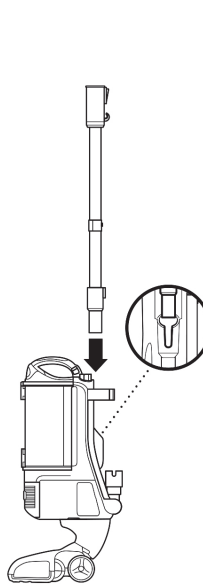

2 Slide wand into base of pod.

#### STEP 3

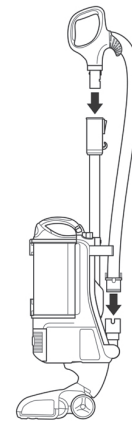

3 Insert handle into top of wand. Then attach hose into base of pod.

#### STEP 4

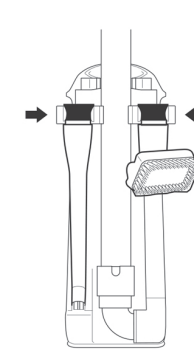

4 Insert tools into accessory clips, then tuck the hose between the clips.

### USING YOUR VACUUM IN UPRIGHT MODE

⚠ **WARNING: DO NOT use to vacuum up drywall dust, fireplace ash, or embers. DO NOT use as an attachment to power tools for dust collection.**

#### WHAT DOES THE BRUSHROLL INDICATOR LIGHT MEAN?

**Solid Green**  
The brushroll is on and working as it should.

**Solid Red**  
There is a jam in the brushroll area. Turn your vacuum off and remove the blockage.

**No Light**  
The brushroll is off. To turn it on, press the BRUSHROLL button. The light should turn green, and the brushroll should spin.



#### STEP 2

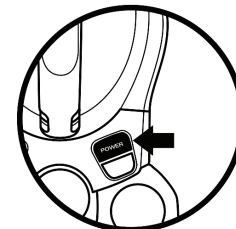

2 Press POWER to clean hard-floor surfaces, area rugs, or above floor. The brushroll will not spin in this mode.

#### STEP 3

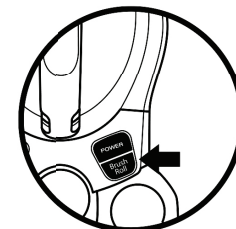

3 Press POWER and BRUSHROLL to clean carpets. The Brushroll Indicator Light will illuminate green. The brushroll will spin only when the vacuum is reclined and the Brushroll Indicator Light is green.

**NOTE:** For deep cleaning per ASTM F 608 (embedded dirt in carpets), please ensure brushroll is on with the suction control closed.

### USING YOUR VACUUM IN ABOVE-FLOOR MODE

#### THE BENEFITS OF SUCTION CONTROL

Suction Control is a way for you to adjust suction power when you are using different tools or vacuuming different surfaces. For example, if you are feeling resistance while vacuuming thick carpet or upholstery, slide the Suction Control to the left to MIN to help reduce your push/pull effort.

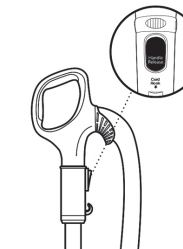

1 Press Handle Release button when you need to clean within short reach.

#### STEP 1



**OR** Press Wand Release button on pod when you need to clean with a longer reach.

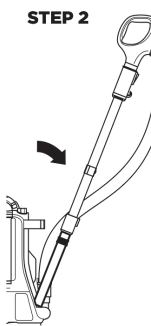

#### STEP 2

2 Insert wand or handle directly into desired tool and pivot back to release tool from clip.

#### STEP 3

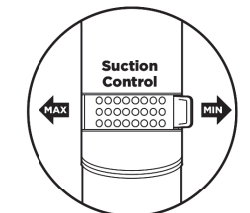

3 The Suction Control collar is located at the base of the top handle. Suction Control offers variable suction based on your needs. Slide toward MIN to minimize suction, and slide toward MAX to maximize suction.

### USING YOUR VACUUM IN LIFT-AWAY® MODE

⚠ **WARNING: Lift-Away mode requires stable footing. Using Lift-Away mode without stable footing may result in personal injury.**

⚡ **TIP:** Hold pod in hand when cleaning in Lift-Away mode.

#### WHAT IS LIFT-AWAY?

Our Lift-Away feature allows you to remove the pod from the floor nozzle to easily clean stairs, above-floor areas with accessories, or hard floors with the hard-floor attachments.

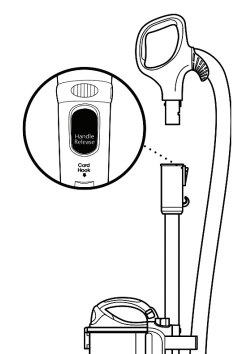
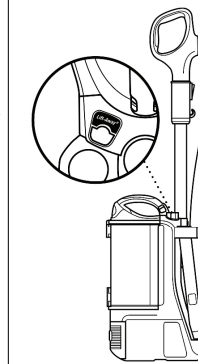

#### LIFT-AWAY CLEANING

1 Press Lift-Away to lift pod off floor nozzle.

2 Press Handle Release button when you need to clean within short reach.

\*Accessories may vary depending on model.

\*Your Quick Start Guide shows the accessories that are included with your model.

## MAINTENANCE

To keep your vacuum's suction power optimal, follow these instructions. Make sure unit is off and cord is unplugged.

**WARNING:** To reduce the risk of shock and unintended operation, turn power off and unplug unit before servicing.

Hand wash with water only to prevent damage from cleaning chemicals. Allow ALL filters to dry completely before replacing in the vacuum to prevent liquid from being drawn into electric parts.

**IMPORTANT:** Do not use soap when cleaning the HEPA filter.

### RECOMMENDED FILTER CLEANING SCHEDULE:

**Pre-Motor Filter Kit**  
(Foam & Felt)  
XFF500  
Clean every 3 months.

**Post-Motor Filter**  
(HEPA) XHF500  
Clean once a year.

STEP 1

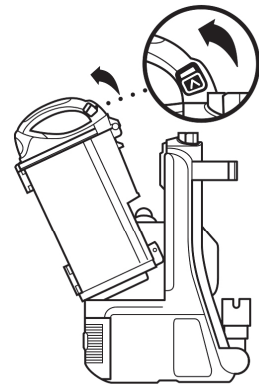

STEP 2

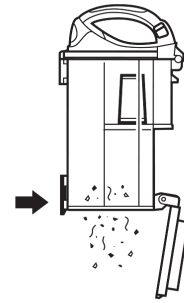

### EMPTYING THE DUST CUP

- 1 Pull up on dust cup release latches and lift dust cup off pod.
- 2 Hold dust cup over a trash bin and press the empty-release latch on the bottom.

STEP 3

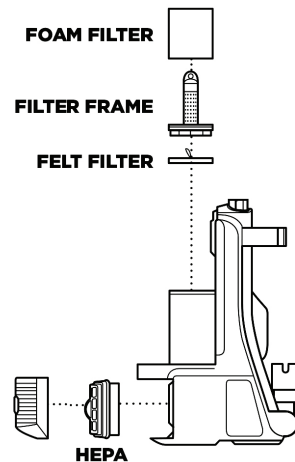
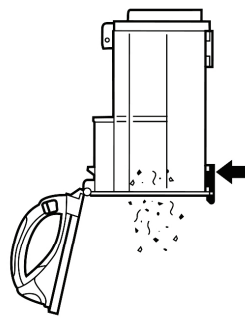

### CLEANING THE FILTERS

- 3 Press top dust-cup release latch to access dust screen and remove built-up debris as required.

- 1 **Pre-Motor (foam and felt):** With the dust cup removed, take out the foam and felt filters, and rinse with water. Tap loose dirt off filters between washes as needed.
- 2 **Post-Motor (HEPA):** To access the HEPA filter, press the button on top of the grill, and pull the grill away from the vacuum. Remove and rinse the HEPA filter.

## MAINTENANCE

**WARNING:** To reduce the risk of shock and unintended operation, turn power off and unplug unit before servicing.

**TIP:** You can also check for blockages in the hose and tubes. Just remove floor nozzle, dust cup, wand, and hose and shine a flashlight in the openings.

STEP 1

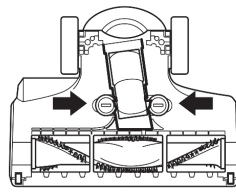

STEP 2

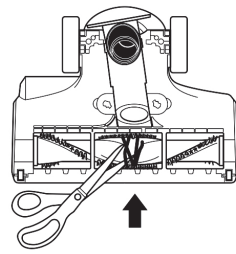

### BOTTOM OF FLOOR NOZZLE

- 1 Using a coin, turn the screws to the unlock position and pull up to expose the airway. Remove the blockage.
- 2 Remove any string, hair or debris that may be wrapped around the brushroll.

STEP 1

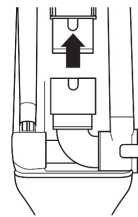

STEP 2

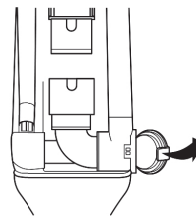

### HOSE CUFF AT BASE OF POD

- 1 Squeeze tabs and remove hose.
- 2 Open the clog access knob on the side of the pod.

There are a variety of accessories that are compatible with this vacuum series.

**Note:** Your Quick Start Guide shows the accessories that are included with your model.

### POLARIZED PLUG

To reduce the risk of electric shock, this vacuum cleaner has a polarized plug (one blade is wider than the other). As a safety feature, this plug will fit into a polarized outlet only one way. If the plug does not fit fully into the outlet, reverse the plug. If it still does not fit, contact a qualified electrician. DO NOT force into outlet or try to modify to fit.

SharkNinja Operating LLC  
US: Newton, MA 02459  
CAN: Ville St-Laurent, QC H4S 1A7

Illustrations may differ from actual product.  
Lift-Away, Rotator, and Shark are registered trademarks of SharkNinja Operating LLC.  
For SharkNinja U.S. Patent information, visit [sharkninja.com/USPatents](http://sharkninja.com/USPatents).

### TECHNICAL SPECIFICATIONS

Voltage: 120V, 60Hz  
Watts: 1200W  
Amps: 10A



PRINTED IN MEXICO Elbrd: M.C  
OBPN: NV500\_Series\_IB\_E\_160627  
8 0 4 1 0 8 9 2 8 SC: 01-03-2023\_R redesign SHNMDL: NV500\_B

## TROUBLESHOOTING GUIDE

**WARNING:** To reduce the risk of shock and unintended operation, turn power off and unplug unit before servicing.

**Vacuum is not picking up debris. No suction or light suction.**  
(Refer to Maintenance section for more information.)

- Check filters to see if they need cleaning. Follow instructions for rinsing and drying the filters before re-inserting in the vacuum.
- Dust cup may be full; empty dust cup.
- Check hose, hose connections, nozzles, and accessories for blockages; clear blockages if required.
- Remove any string, carpet fibers, or hair that may be wrapped around the brushroll.

### Vacuum lifts area rugs.

- Turn off unit to disengage the brushroll. Ensure brushroll is turned off and restart with the POWER button for suction only cleaning.
- Suction is powerful. Take care when vacuuming area rugs or rugs with delicately sewn edges.
- To minimize suction, refer to Suction Control section for more information on how to use.

### Brushroll does not spin.

- If Brushroll Indicator Light on the floor nozzle turns red, the brushroll has stopped spinning. Immediately turn off and unplug vacuum, disconnect the nozzle, and remove blockage before reconnecting and turning vacuum back on.
- With the power on, recline the handle, which will automatically turn on the brushroll.
- Ensure that the BRUSHROLL button is on for brushroll to spin

### Vacuum turns off on its own or indicator light flashes red.

- This vacuum is equipped with a motor-protective thermostat. If your vacuum overheats, the thermostat will automatically turn the suction motor off. Perform the following steps to restart the thermostat:
  1. Turn vacuum off and unplug it.
  2. Empty dust cup and clean filters (see Maintenance section).
  3. Check for blockages in hose, accessories, and inlet openings.
  4. Allow unit to cool for a minimum of 45 minutes.
  5. Plug in vacuum and turn it on.
  6. Restart the unit using either the POWER or BRUSHROLL buttons.

**Note:** If vacuum still does not start, contact a service center.

# Shark ROTATOR

804009438A

## QUICK START GUIDE

LIFT-AWAY<sup>®</sup>  
PROFESSIONAL

### WHAT'S INSIDE

- A** Handle
- B** Hose
- C** Wand
- D** Vacuum Pod
- E** Motorized Floor Nozzle
- F** Upholstery Tool
- G** Crevice Tool
- H** Dusting Brush

### ASSEMBLY

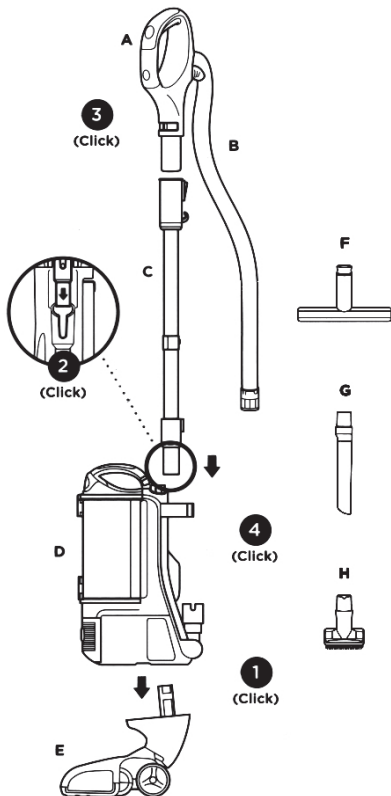

### ATTACH ONBOARD ACCESSORIES

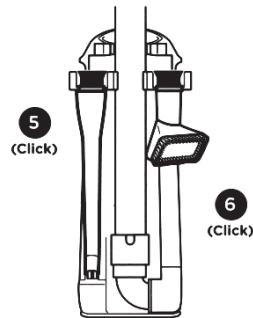

### MAINTENANCE

Empty the dust cup after each use.

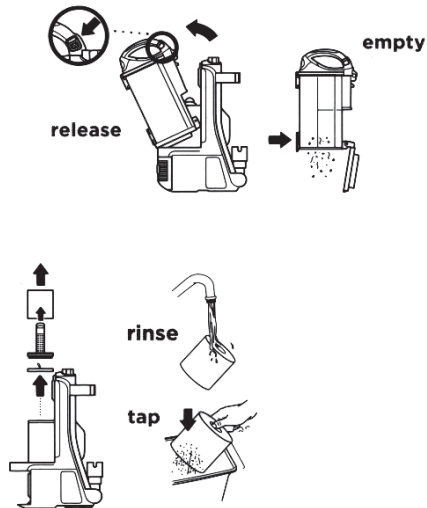

### 2 WAYS TO CLEAN

#### UPRIGHT

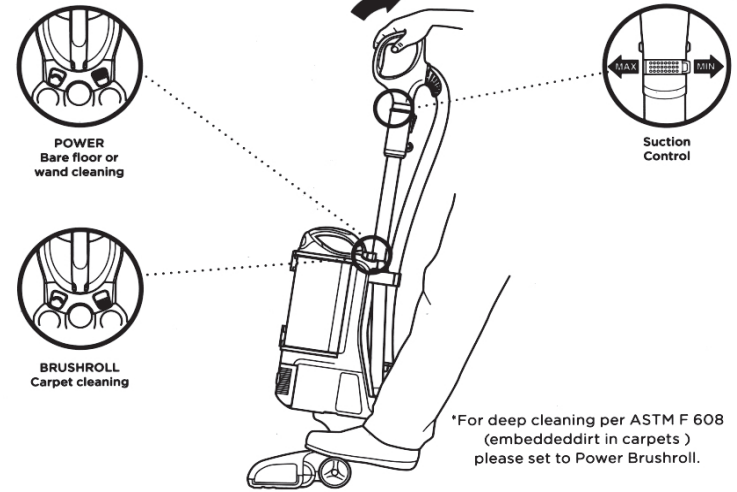

#### LIFT-AWAY<sup>®</sup>

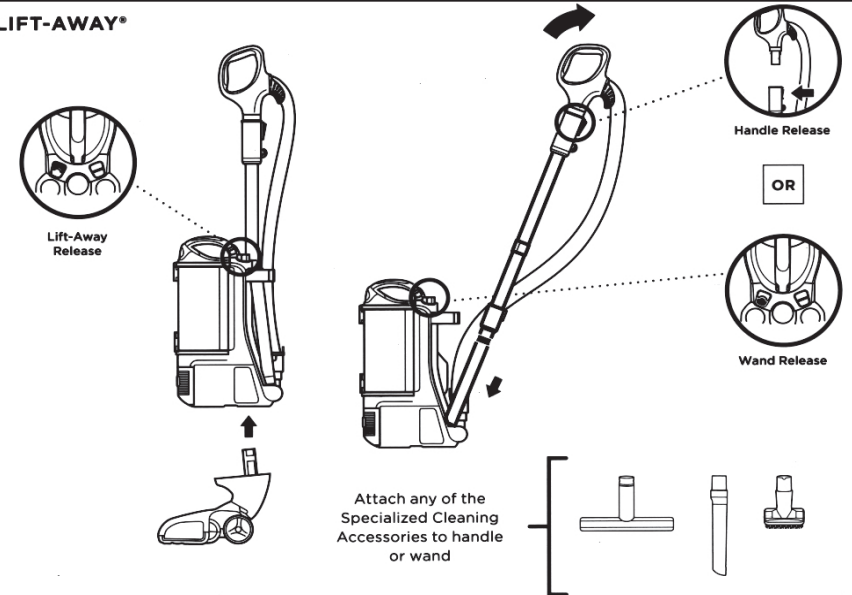

Notes: The images shown here are for illustrative purpose only and may vary.

\* Accessories may vary depending on the model

Notes: The images shown here are for illustrative purpose only and may vary.

\* Accessories may vary depending on the model



8 0 4 0 0 9 4 3 8 A

PRINTED IN MEXICO

Elbrd: Y.T.

OBPN: N/A SC: 07-15-2021\_1P

MODEL: NV501