

Shark[®]

Owner's Guide

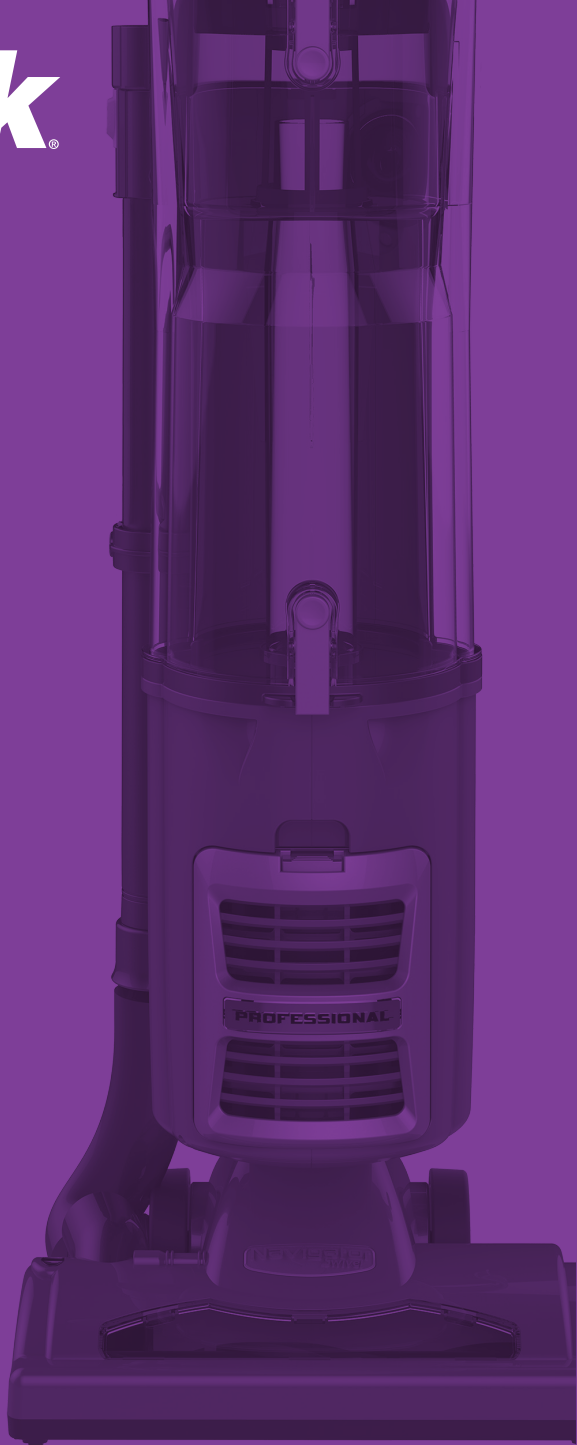

TECHNICAL SPECIFICATIONS Voltage:
120V.

Amps: 10A
Hertz: 60Hz

Contents

Thank you for
purchasing
the **Shark®**
Navigator®.

Important Safety Instructions	2
Getting Started	4
Using the Vacuum	6
Cleaning with the Vacuum Accessories	7
Emptying the Dust Cup Assembly	8
Proper Care of Your Vacuum	9
Troubleshooting	10
Checking for Blockages	11
Maintenance	12

IMPORTANT SAFETY INSTRUCTIONS

For Household Use Only

WHEN USING YOUR SHARK® NAVIGATOR® VACUUM, BASIC SAFETY PRECAUTIONS SHOULD ALWAYS BE FOLLOWED, INCLUDING THE FOLLOWING:

READ ALL INSTRUCTIONS BEFORE USING YOUR SHARK® NAVIGATOR® VACUUM.

POLARIZED PLUG:

This appliance has a polarized plug (one blade is wider than the other). As a safety feature, this plug will fit into a polarized outlet only one way.

Do not force into the outlet or try to modify the plug to fit.

WARNING:

TO REDUCE THE RISK OF ELECTRIC SHOCK OR INJURY DO NOT USE OUTDOORS OR ON WET SURFACES.

WARNING:

TO REDUCE THE RISK OF FIRE, ELECTRIC SHOCK OR INJURY:

GENERAL ELECTRICAL SAFETY:

1. Unplug from electrical outlet when not in use and before servicing.
2. **DO NOT** use vacuum with a damaged cord or plug. If appliance is not working as it should, has been dropped, damaged, left outdoors, or dropped into water.
3. **DO NOT** pull or carry vacuum by the cord.
4. **DO NOT** unplug by pulling on cord; to unplug, grasp the plug, not the cord.
5. **DO NOT** handle plug or appliance with wet hands.
6. **DO NOT** run the vacuum over the power cord.
7. **DO NOT** use the cord as a handle.
8. **DO NOT** close a door on the cord.
9. **DO NOT** pull cord around sharp corners. The use of an extension cord is not recommended.
10. **DO NOT** leave appliance when plugged in.
11. Keep cord away from heated surfaces.
12. Turn off all controls before plugging or unplugging vacuum cleaner.
13. Always turn off this appliance before connecting or disconnecting motorized nozzle.
14. Store your appliance with the power cord secured around the two cord holders as shown in the storage instructions.

HOSE ATTACHMENTS:

1. **DO NOT** use if air flow is restricted; if the air paths, the hose, or the accessories become blocked, turn the vacuum cleaner off. Remove all obstructions before you turn on the unit again.
2. Keep the end of the hose and accessory openings away from face and body.
3. Keep cleaning tools and hose suction openings away from hair, face, fingers, uncovered feet, or loose clothing.
4. Only use manufacturer's recommended attachments.

GENERAL USE:

1. Use only as described in this manual.
2. **DO NOT** put any objects into openings. **DO NOT** use with any opening blocked; keep free of dust, lint, hair, and anything that may reduce air flow.
3. Keep your work area well lit.
4. Keep the vacuum moving over the carpet surface at all times to avoid damaging the carpet fibers.
5. **DO NOT** place vacuum on unstable surfaces such as chairs or tables.
6. **DO NOT** allow young children to operate the vacuum or use as a toy. Close attention is necessary when used near children.
7. **DO NOT** use vacuum cleaner if it has been dropped, damaged, left outdoors, or submerged in water.
8. **DO NOT** use without dust cup and/or filters in place.

DUST CUP/FILTERS/ACCESSORIES:

Before turning on the vacuum:

1. Make sure that all filters are thoroughly dry after routine cleaning.

2. Make sure that dust cup and all filters are in place after routine maintenance.
3. Make sure accessories are free of blockages.
4. Only use filters and accessories.

GENERAL CLEANING:

1. **DO NOT** pick up large-sized objects.
2. **DO NOT** pick up hard or sharp objects such as glass, nails, screws or coins that could damage the vacuum cleaner.
3. **DO NOT** pick up smoking or burning objects such as hot coals, cigarette butts, fireplace ash or matches.
4. **DO NOT** use to pick up drywall dust.
5. **DO NOT** pick up flammable or combustible materials such as lighter fluid, gasoline, or kerosene or use vacuum in areas where they may be present.
6. **DO NOT** pick up toxic solutions such as chlorine bleach, ammonia, or drain cleaner.
7. **DO NOT** use in an enclosed space where vapors are present from paint, paint thinner, moth-proofing substances, flammable dust or other explosive or toxic materials.
8. **DO NOT** vacuum up any liquids.
9. **DO NOT** immerse vacuum cleaner in water or other liquids.
10. **DO NOT** use outdoors or on wet surfaces; use only on dry surfaces.
11. Use extra care when cleaning on stairs.

SAVE THESE INSTRUCTIONS

Getting Started

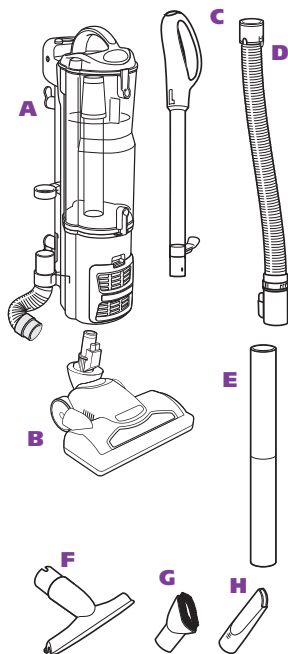

WHAT'S IN THE BOX YOU JUST OPENED:

- A** Vacuum Body
- B** Floor Power Nozzle
- C** Handle Assembly
- D** Super Stretch Hose
- E** Cleaning Wand
- F** Upholstery Tool
- G** Dusting Brush
- H** Crevice Tool

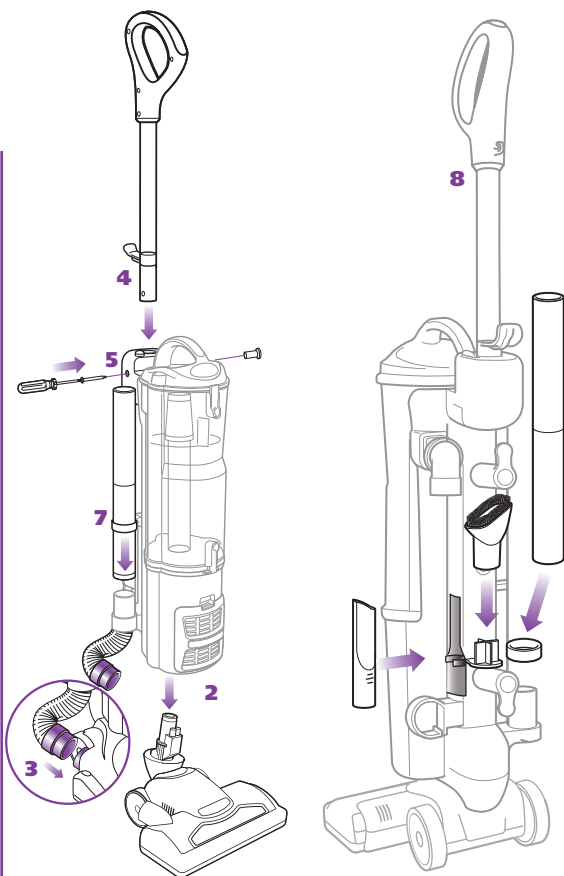

Your Shark® Navigator® is easy to assemble:

- 1** Lay your vacuum body on a level surface.
- 2** Slide the electrical connection from the power nozzle into the main body to click into place.
- 3** Connect the hose from the main body to the power nozzle; push with a slight turning motion to create a snug fit.
- 4** Slide the handle assembly into the upright unit aligning the hose hook on the handle assembly with the power cord hooks on the back of the unit.
- 5** Secure the handle assembly in place with included nut/bolt (shipped attached to handle assembly).
- 6** Place the vacuum in the upright position.
- 7** Insert the Cleaning Wand into the center post on the tool caddy.
- 8** Store the Crevice Tool, Dusting Brush on the back of the unit.

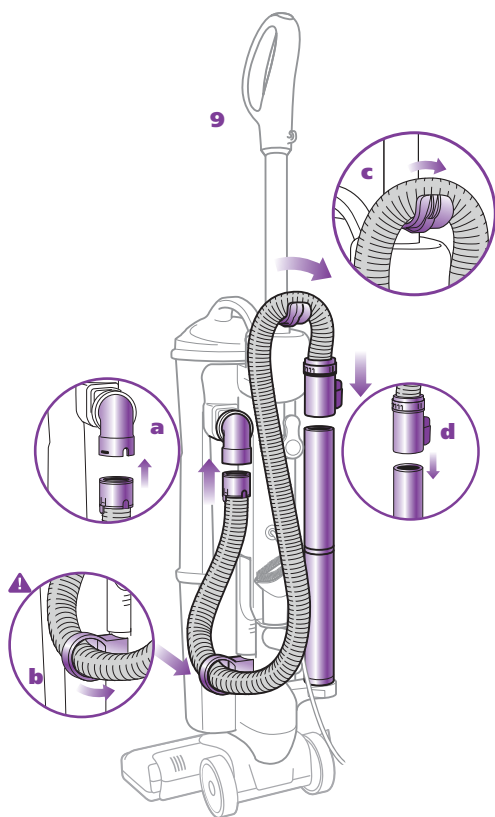

9 Attach the Super Stretch Hose:

- a)** Snap hose into swivel connector
- b)** Route under anti-tip hook to prevent vacuum from tipping
- c)** Route over upper hose holder
- d)** Press securely onto cleaning wand with handle

! IMPORTANT:
Insert the hose into the wand. This completes the air path and enables suction to reach the Floor Power Nozzle.

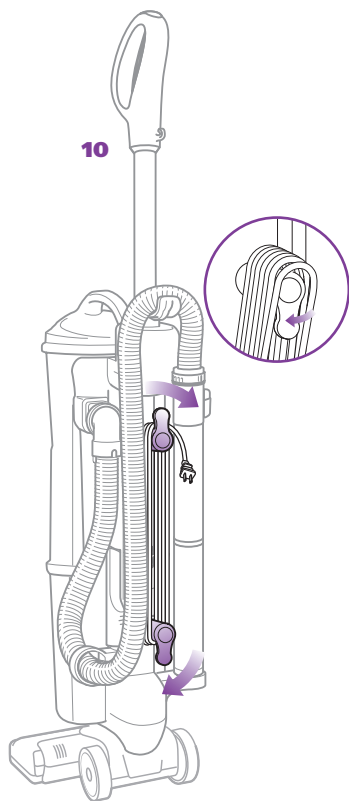

10 To store the vacuum:

When storing your vacuum, wind the cord around the two cord holders and secure with cord clip:

- Quick Cord release at the top of the unit – place in the upright position.
- Cord holder near the base – turn it until it is pointing down.

To release the cord, turn the Quick Cord release to the left or right.

11 To carry the vacuum:

With the unit in the standing position, lift by the Dust Cup Assembly Handle (carry handle).

! CAUTION: When lifting or carrying, **DO NOT** press Dust Cup Assembly release button.

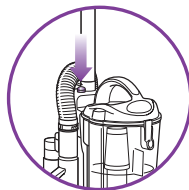

Using the Vacuum

IMPORTANT: To protect your carpets, the brushroll will only turn on when you have pulled the handle back towards you and released the Floor Power Nozzle.

3 Power Switch Settings

OFF

Bare Floors /
Tools

Carpets

4

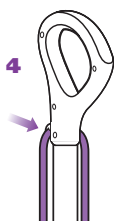

 Release suction for easier push and pull on high pile carpets and area rugs.

Suction Release

6

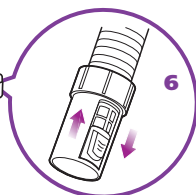

Your **Shark® Navigator®** Vacuum can be used to clean bare floors or carpets – with the click of a switch. Stand the vacuum into the upright position.

Plug in the vacuum.

- 1 Start with the Power Switch in the "O" - Off position.
- 2 Place your foot on the Floor Power Nozzle and pull handle towards you.
- 3 Set the Power Switch to desired cleaning setting.
- 4 Push the power cord into the groove on the handle and then secure the power cord into the cord clip.

5 Press the On/Off switch to the "I" position to vacuum bare floors or cleaning with the hose (straight suction only) or to the "II" position to engage the motorized floor brush (for vacuuming carpets and rugs).

6 Due to the huge suction power of this vacuum, it may become necessary to adjust the suction release on the hose. If the vacuum is difficult to push or pull or if it is lifting up area rugs, adjust the suction release by opening the valve at the top end of the hose. Close the suction release valve for maximum suction when vacuuming floors or when using the Wide Upholstery Tool.

IMPORTANT:

Your Brushroll Indicator Light will illuminate solid green when the brushroll is on, or solid red if there is a blockage. This feature is designed to protect your Lifetime Belt that powers your brushroll. **See Checking for Blockages.**

NOTE: The height of your power nozzle has been optimized for easy pushing and superior cleaning on all floor types, so there is no need to make any height adjustments as you transition to different floor & carpet types.

Cleaning with the Vacuum Accessories

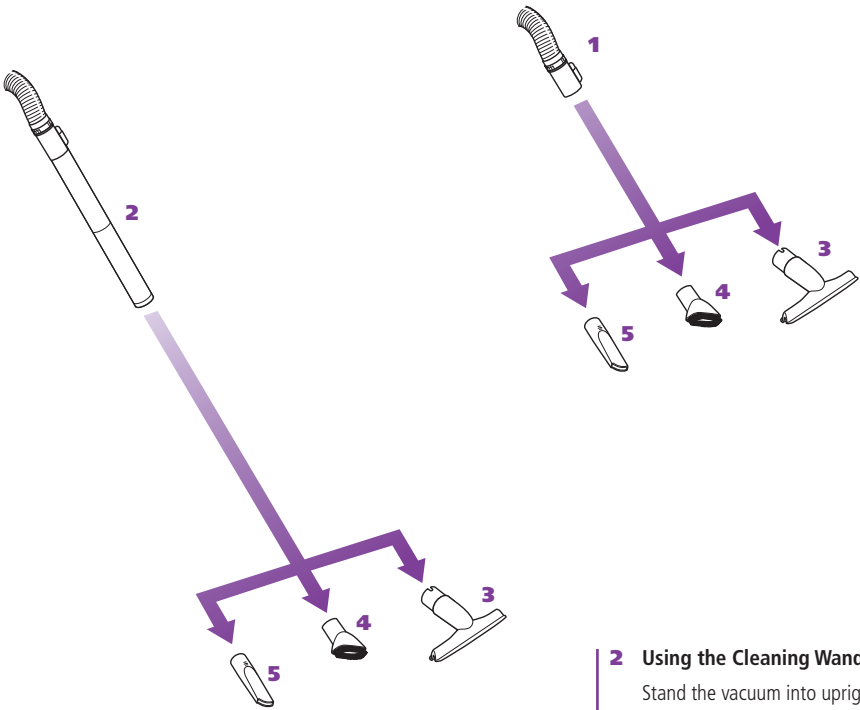

Before cleaning with your accessories:

Stand vacuum into upright position.

Secure Super Stretch Hose in the anti-tip hose hook to prevent tipping.



Select the "I" - On position for suction only cleaning.

! DO NOT pull vacuum cleaner around by the hose.

! DO NOT overextend the hose.

Vacuum Accessories

Your vacuum comes with a Super Stretch Hose and Cleaning Wand. Use one or the other to attach your cleaning accessories.

1 Using the Super Stretch Hose:

Stand the vacuum into upright position.

Remove the hose from the Cleaning Wand.

Push the selected tool into the hose connector.

2 Using the Cleaning Wand:

Stand the vacuum into upright position.

Remove the Cleaning Wand (with hose attached) from the unit.

Push the selected tool into the end of the Cleaning Wand.

3 Wide Upholstery Tool

4 Dusting Brush

5 Crevice Tool

Maintenance

For best results empty the Dust Cup Assembly after each use, as needed during prolonged usage or when it reaches the **MAX** fill line.

DO NOT OVERFILL.

Turn vacuum off before emptying.

CAUTION:

Unplug the vacuum; failure to do so might result in electric shock.

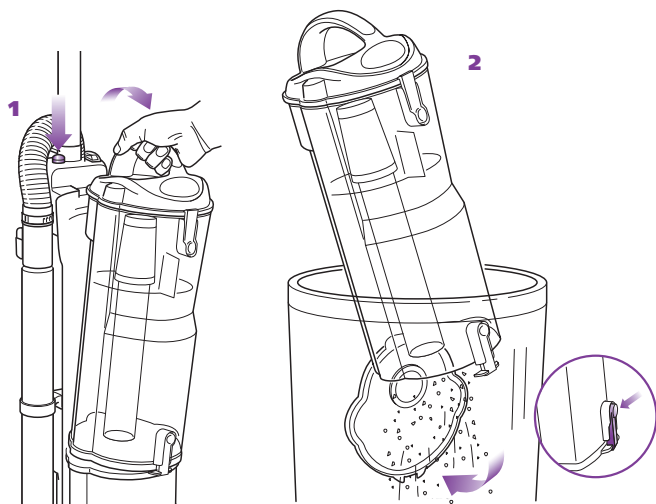

To empty the Dust Cup:

- 1 Grip carry handle and press the Dust Cup release button to remove.

- 2 **Option A:** For Quick Empty: Insert Dust Cup deep inside trash receptacle to contain dust and debris.

Press the bottom Dust Cup release button; tap container gently to dislodge and release dust and debris.

Snap door in place.

- 4 **Important:** If the Dust Cup Door does not swing open after pressing the release button, push the door open using the bottom door tabs.

! Note: Some dust and debris may remain in the top of your dust cup on or near the metal screen. It is not necessary to completely remove this material before continuing to vacuum; *Shark*[®] advanced cyclonic action will sweep the metal screen clean once you begin to refill your dust cup.

COMPONENT	MAINTENANCE SCHEDULE
1 Dust Cup	Empty each time you vacuum.
2 Pre-Motor Foam Filter	Rinse and air dry every month under normal use.
3 Pre-Motor Felt Filter	Rinse and air dry every month under normal use.
4 Post-Motor HEPA Filter	Clean once a year under normal use.

- ⚠ **DO NOT** operate the vacuum without ALL the filters in place.
- ⚠ **DO NOT** operate the vacuum with WET filters.

⚠ **IMPORTANT: Loss of Suction may occur** if foam filter is not cleaned every month. Rinse and allow to air dry completely. Also, tap loose dirt off filter between washes as needed. Foam filters may appear dirty after use - this is normal.

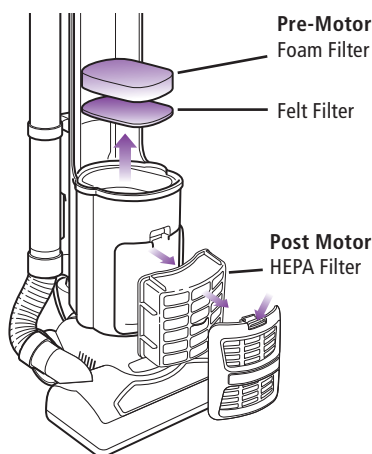

To clean the pre-motor filters:

- 1 Remove the dust cup.
- 2 Pull the 2 filters out from the top of the motor base.
- 3 Rinse the filters thoroughly in lukewarm water until the water runs clear.

⚠ **DO NOT** put the filters in the washing machine or dishwasher.

NOTE: The material in the filters will discolor over time. This is NORMAL and will not affect the performance of the filters.

- 4 Squeeze out excess water and let air-dry for at least 24 hours before replacing. Do not use a hair dryer or other heating methods to dry.
- 5 Place the felt filter in first, then the foam filter.
- 6 Replace the dust cup.



To clean the post-motor HEPA filter:

- 1 Remove the filter cover from the front of the vacuum by pulling up on the tab and pulling the cover away from the vacuum.
- 2 Take out the HEPA filter by pulling it straight out.
- 3 Turn the HEPA filter over so that the dirty side is on the bottom and vigorously tap it clean against a garbage can to remove any dust.
- 4 Wash the HEPA filter under the tap using lukewarm water with the dirty side face down until the water runs clear.

⚠ **DO NOT** put the HEPA filter in the washing machine or dishwasher.

NOTE: The material in the filter will discolor over time. This is NORMAL and will not affect the performance of the filter.

- 5 Allow the HEPA filter to air dry for 24 hours. Do not use a hair dryer or other heating methods to dry.
- 6 Once the HEPA filter is dry, replace it back into the vacuum.
- 7 Replace the cover by inserting the two tabs into the holes at the bottom and then swinging the cover up until it clicks into place.

Troubleshooting

WARNING:

To reduce the risk of electric shock, the power cord must be disconnected before performing maintenance/troubleshooting checks.

PROBLEM	POSSIBLE REASONS & SOLUTIONS
Vacuum is not picking up dirt.	<p>Check filters to see if they need cleaning. Follow instructions for rinsing and drying the filters before re-inserting back into the vacuum. (See "Maintenance" sections for instructions.)</p> <p>Dust cup may be full; empty dust cup.</p> <p>Check hose and hose connections for blockages; clear blockages if required.</p> <p>If dust cup is empty, and attachment inlets are clear, check for other blockages. (See "Checking for Blockages" for instructions.)</p>
Vacuum lifts scatter rugs (lightweight, movable rugs).	<p>Suction is powerful. Take care when vacuuming scatter-type rugs or rugs with delicately sewn edges. Open the suction release on the hose to decrease suction power.</p>
Airflow is restricted. No suction or light suction.	<p>Check filters to see if they need cleaning. Follow instructions for rinsing and drying the filters before re-inserting back into the vacuum. (See "Maintenance" sections for instructions.)</p> <p>Dust cup may be full; empty dust cup.</p> <p>Check hose, hose connections, nozzles and accessories for blockages; clear blockages if required.</p> <p>Close the suction release on the hose to increase suction power.</p> <p>If dust cup is empty, and attachment inlets are clear, check for other blockages. (See "Checking for Blockages" for instructions.)</p>
Motorized floor brush has become jammed or has shut off.	<p>Immediately turn off and unplug vacuum, disconnect the nozzle and remove blockage before reconnecting and turning vacuum back on. (See "Checking for Blockages" for instructions.)</p>
Vacuum turns off on its own.	<p>This vacuum cleaner is equipped with a motor protective thermostat. If for some reason your vacuum overheats, the thermostat will automatically turn the unit off. Should this occur, perform the following steps to restart the motor thermostat:</p> <ol style="list-style-type: none">1. Move the On/Off switch to the "O" (Off) position.2. Unplug the vacuum.3. Empty the dust cup and clean filters. (See "Maintenance" sections for instructions.)4. Check for blockages in hose, accessories and inlet openings. (See "Checking for Blockages" for instructions.)5. Allow the unit to cool for a minimum of 45 minutes.6. Plug in the vacuum.7. Turn the On/Off switch to the "I" (On) position to restart the vacuum. <p>Note: If vacuum still does not start, contact a service center.</p>

Checking for Blockages

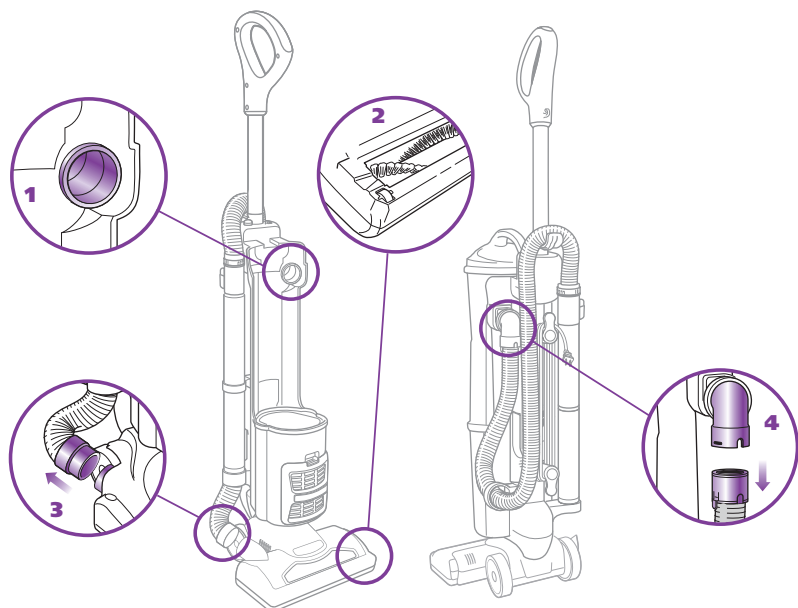

Unplug the vacuum before checking for blockages.

Reassemble all parts securely before operating vacuum.

Blockages may cause your vacuum to overheat and shut down. If so, clear the blockages, then follow the instructions for **Resetting the Motor Thermostat**.

⚠ WARNING: Never insert sharp objects into any opening to clear an obstruction.

⚠ IMPORTANT: Damages caused while clearing or attempting to clear blockages are not covered under your product's limited warranty.

1 Dust Cup Air Duct:

Stand vacuum into upright position.

Remove Dust Cup Assembly and empty Dust Cup if necessary.

Disconnect the Super Stretch Hose.

Check Air Duct behind Dust Cup for clogs; clear before replacing Dust Cup Assembly.

2 Intake Opening behind the Brushroll:

Lay the vacuum flat to expose brushroll.

Check opening behind the brushroll for clogs.

Clear the opening.

Clear the brushroll; use scissors to carefully cut away threads, hair or other debris that might be trapped in the bristles.

3 Floor Power Nozzle Hose Connector:

Lay vacuum flat.

Remove Nozzle Hose and check for clogs.

Push the Hose Connector back onto the Floor Power Nozzle.

4 Hose:

Stand vacuum upright.

Remove hose from both the unit and Cleaning Wand ends.

Inspect both ends and the length of the hose for clogs.

Return the hose to the unit.

Maintenance

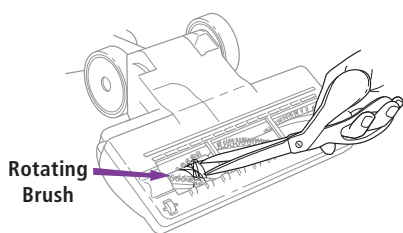

Cleaning The Motorized Floor Brush

When your motorized floor brush needs cleaning or locks onto an object, it automatically shuts down to prevent damage to your lifetime belt. The indicator light will illuminate red warning you to turn off the vacuum and clear blockage immediately. The light will reset itself once blockage has been cleared and power has been cycled on/off or vacuum has been locked in the upright position.

- 1 Detach the motorized floor brush from the detachable canister.
- 2 Inspect the opening underneath and the rotating brush. If a build-up of debris is present, remove it. Carefully cut anything wound around the rotating brush with scissors. Avoid damaging or cutting the bristles.

Resetting the Motor Thermostat

Your **Shark® Navigator®** Vacuum is equipped with a protective Motor Thermostat. If the motor should overheat, the thermostat shuts off the power.

To reset the Motor Thermostat:

Move the Power Button to the “O” – Off position.

Unplug the vacuum.

Check for clogged hose or filter; unclog hose and replace filter.

Refer to **Checking for Blockages**.

Wait 45 minutes for vacuum to cool; then plug in the vacuum.

Turn the Power Switch to the “I” – On position to start the vacuum.

Note: If vacuum still does not start, contact a service center.

PART	PART NO.
Super Stretch Hose	152FFJ
Dusting Brush & Crevice Tool	1115FC
Foam & Felt Filters	XFF80
Hepa Filter	XHF80
Wide Upholstery Tool	261FFJ46
Cleaning Wand	114FFJ



SharkNinja Operating LLC

Illustrations may differ from actual product. We are constantly striving to improve our products, therefore the specifications contained herein are subject to change without notice.

804008284



PRINTED / ELBRD:J.E.
OBPN: NV60_QSG_MP_REV_Mv7
SC: 10-20-2023 / SHNMDL: NV60_B