

Shark® EZ ROBOT

SELF-EMPTY

Robot Vacuum



Please read this manual carefully before operating your unit and retain for future reference.

804106797

IMPORTANT SAFETY INSTRUCTIONS

PLEASE READ CAREFULLY BEFORE USE • FOR HOUSEHOLD USE ONLY

If the charging cable plug does not fit fully into the outlet, reverse the plug. If it still does not fit, contact a qualified electrician. DO NOT force into outlet or try to modify to fit.

WARNING

To reduce the risk of fire, electric shock, injury, or property damage:

GENERAL WARNINGS

When using an electrical appliance, basic precautions should always be followed, including the following:

1. Robotic vacuum cleaner consists of a robotic vacuum and charging base with power supply. These components contain electrical connections, electrical wiring, and moving parts that potentially present risk to the user.
2. Before each use, carefully inspect all parts for any damage. If a part is damaged, discontinue use.
3. Use only identical replacement parts.
4. This robotic vacuum cleaner contains no serviceable parts.
5. Use only as described in this manual. DO NOT use the robotic vacuum cleaner for any purpose other than those described in this manual.
6. With the exception of filters, DO NOT expose any parts of the robotic vacuum cleaner to water or other liquids.

USE WARNINGS

7. This appliance can be used by persons with reduced physical, sensory or mental capabilities or lack of experience and knowledge if they have been given supervision or instruction concerning use of the appliance in a safe way and understand the hazards involved.
 - a) Children shall not play with the appliance.
 - b) Cleaning and user maintenance shall not be made by children without supervision.
8. Always turn off the robotic vacuum cleaner before inserting or removing the filter or dust bin.
9. DO NOT handle plug, charging base, charging cable, or robotic vacuum cleaner with wet hands. Cleaning and user maintenance shall not be made by children without supervision.
10. DO NOT use without robot dust bin and filters in place.
11. DO NOT damage the charging cord:
 - a) DO NOT pull or carry charging base by the cord or use the cord as a handle.
 - b) DO NOT unplug by pulling on cord. Grasp the plug, not the cord.
 - c) DO NOT close a door on the cord, pull the cord around sharp corners, or leave the cord near heated surfaces.
12. DO NOT put any objects into nozzle or accessory openings. DO NOT use with any opening blocked; keep free of dust, lint, hair, and anything that may reduce airflow.
13. DO NOT use if robotic vacuum cleaner airflow is restricted. If the air paths become blocked, turn the vacuum cleaner off and remove all obstructions before turning on the unit again.
14. Keep nozzle and all vacuum openings away from hair, face, fingers, uncovered feet, or loose clothing.
15. DO NOT use if robotic vacuum cleaner is not working as it should, or has been dropped, damaged, left outdoors, or dropped into water.
16. DO NOT place vacuum cleaner on unstable surfaces.
17. DO NOT use to pick up:
 - a) Liquids
 - b) Large objects
 - c) Hard or sharp objects (glass, nails, screws, or coins)
 - d) Large quantities of dust (drywall dust, fireplace ash, or embers). DO NOT use as an attachment to power tools for dust collection.

- e) Smoking or burning objects (hot coals, cigarette butts, or matches)
 - f) Flammable or combustible materials (lighter fluid, gasoline, or kerosene)
 - g) Toxic materials (chlorine bleach, ammonia, or drain cleaner)
18. DO NOT use in the following areas:
 - a) Wet or damp surfaces
 - b) Outdoor areas
 - c) Spaces that are enclosed and may contain explosive or toxic fumes or vapors (lighter fluid, gasoline, kerosene, paint, paint thinners, mothproofing substances, or flammable dust)
 - d) Near fireplaces with unobstructed entrances.
 - e) In an area with a space heater.
 19. Turn off the robotic vacuum cleaner before any adjustment, cleaning, maintenance or troubleshooting.
 20. Allow all filters to air-dry completely before replacing in the robotic vacuum cleaner to prevent liquid from being drawn into electric parts.
 21. DO NOT modify or attempt to repair the robotic vacuum cleaner or the battery yourself, except as indicated in this manual. DO NOT use the vacuum if it has been modified or damaged.
 22. To reduce the risk of electric shock, this appliance has a polarized plug (one blade is wider than the other). This plug will fit in a polarized outlet only one way. If the plug does not fit fully in the outlet, reverse the plug. If it still does not fit, contact a qualified electrician to install the proper outlet. Do not change the plug in any way.
 23. In case the self-empty base has a thermal shutoff the unit needs to have a hard power reset to restart.

BATTERY USE

24. The battery is the power source for the vacuum. Carefully read and follow all charging instructions.
25. To prevent unintentional starting, ensure the vacuum is powered off before picking up or carrying the vacuum. DO NOT carry the appliance with your finger on the power switch.
26. Use ONLY the Shark™ self-empty base and use only battery. Use of batteries or battery chargers other than those indicated may create a risk of fire.
27. Keep the battery away from all metal objects such as paper clips, coins, keys, nails, or screws. Shorting the battery terminals together increases the risk of fire or burns.
28. Under abusive conditions, liquids may be ejected from the battery. Avoid contact with this liquid, as it may cause irritation or burns. If contact occurs, flush with water. If liquid contacts eyes, seek medical help.
29. Robotic vacuum cleaner should not be stored, charged, or used at temperatures below 50°F (10°C) or above 104°F (40°C). Ensure the battery and vacuum have reached room temperature before charging or use. Exposing the robot or battery to temperatures outside of this range may damage the battery and increase the risk of fire.
30. DO NOT expose the robotic vacuum cleaner or battery to fire or temperatures above 265°F (130°C) as it may cause explosion.
31. Non-rechargeable batteries cannot be recharged.

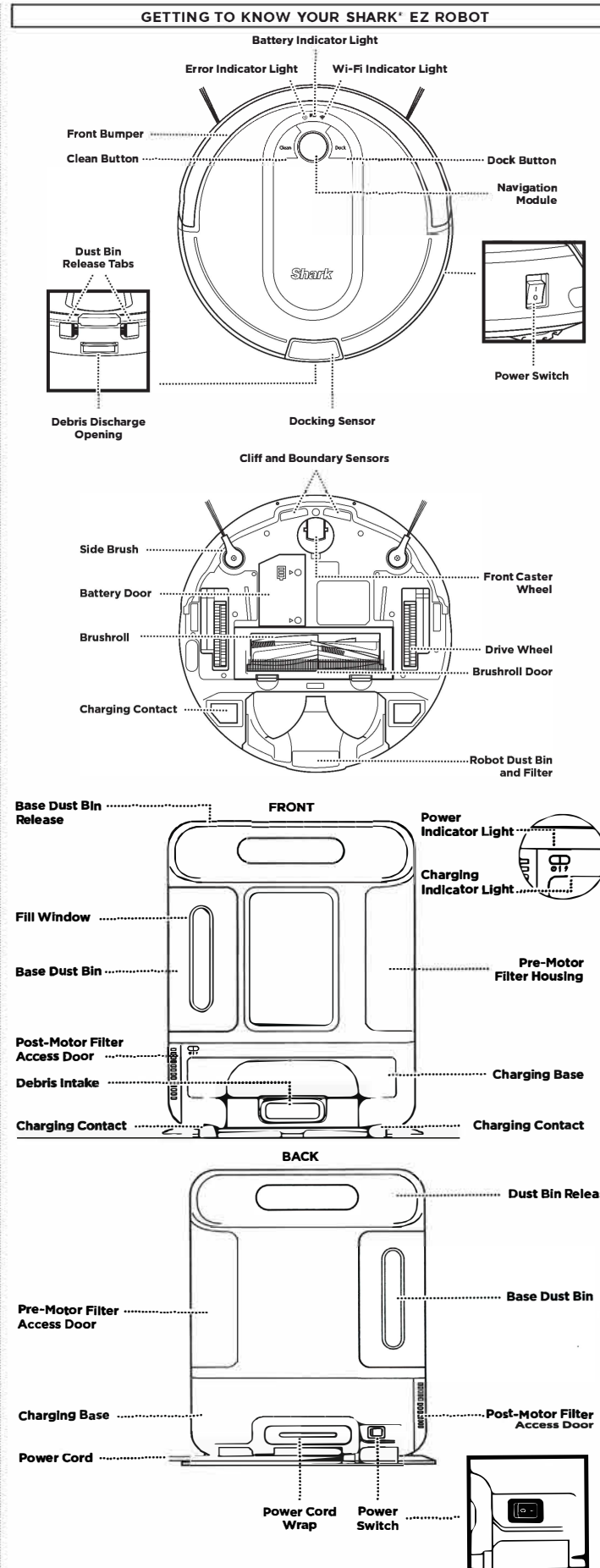

NOTE: Accessories may vary depending on the model. Refer to quick guide, if available. The images shown here are for illustrative purposes only and may be subject to change.

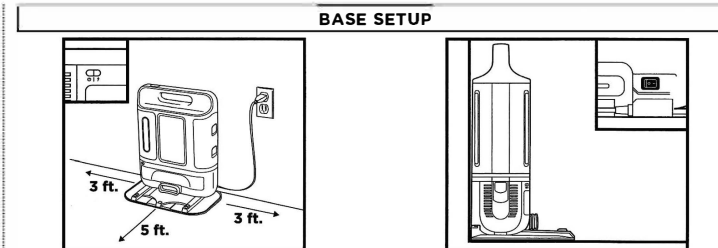

- The Self-Empty Base charges your robot and holds dirt and debris from up to 30 days of cleaning.
- Select a permanent location for the base. Every time you move the base, your robot will be required to completely re-map your house.
 - Choose a level surface in a central area. Remove protective film from base.
 - Place the base with its back against the wall, in an area with a good Wi-Fi signal.
 - Set up the base on bare floor.
 - Remove any objects closer than 3 feet from the sides of the base, or closer than 5 feet from the front.
 - Plug in the **Charging Cord**, and turn on the **Power Switch** on the back of the base. When the base is plugged in and the power switch is turned on, the **GREEN Power Indicator Light** on the base will illuminate.

NOTES: For best results, set up on bare floor or thin carpet. Do not place base against heating elements or baseboards, or in direct sunlight. The robot makes a loud noise when it empties its debris into the base. This is normal and not a cause for concern.

CHARGING

IMPORTANT: The Shark IQ Robot™ has a pre-installed rechargeable battery. Battery should be fully charged before using. It may take up to 6 hours to fully charge.

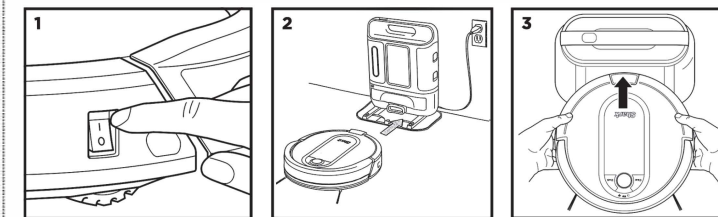

- NOTE:** When manually placing the robot on the base, make sure the **Charging Contacts** on the bottom of the robot are touching the ones on the base and the robot's dust bin is touching the debris intake on the base. While the robot is charging, both blue LED lights will flash. When charging is complete, both blue lights will illuminate steadily.
- NOTE:** When picking up the robot be careful not to place fingers between the bumper and the base of the robot.

NOTE: When manually placing the robot on the base, make sure the **Charging Contacts** on the bottom of the robot are touching the ones on the base and the robot's dust bin is touching the debris intake on the base. While the robot is charging, both blue LED lights will flash. When charging is complete, both blue lights will illuminate steadily.

NOTE: When picking up the robot be careful not to place fingers between the bumper and the base of the robot.

ROBOT BATTERY INDICATOR LIGHT

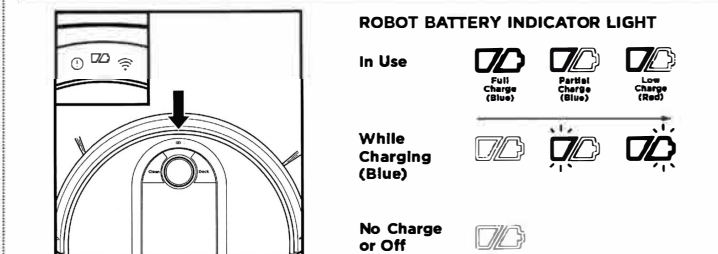

The battery indicator light on the robot shows how much charge is remaining. When the robot is charging, the battery light will flash blue. When charging is complete, the light will illuminate steadily in blue.

NOTE: If the battery indicator light on the robot is blinking red, there is not enough charge for the robot to return to the base. Manually place the robot on the base.

SAVE THESE INSTRUCTIONS

The image shown here is for illustrative purposes only and may be subject to change. Illustrations may differ from actual product.

We are constantly striving to improve our products; therefore the specifications contained herein are subject to change without notice.

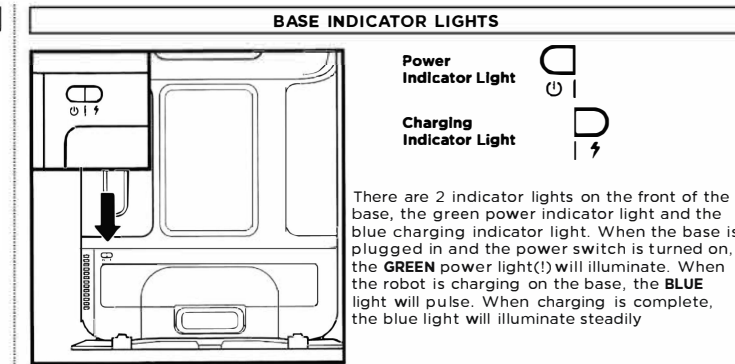

BUTTONS AND INDICATOR LIGHTS

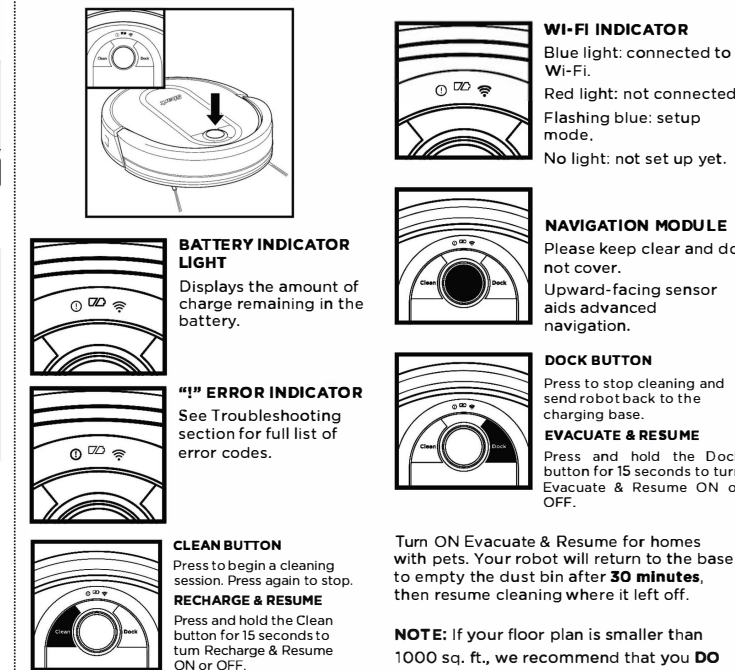

Turn ON Evacuate & Resume for homes with pets. Your robot will return to the base to empty the dust bin after **30 minutes**, then resume cleaning where it left off.

NOTE: If your floor plan is smaller than 1000 sq. ft., we recommend that you **DO NOT** use the Evacuate & Resume function.

PREP YOUR HOME

Your robot uses an array of sensors to navigate around walls, furniture legs, and other obstacles while it cleans. To prevent the robot from bumping into objects or navigating to areas you don't want it to, use the BotBoundary™ strips. To purchase BotBoundary strips, please visit sharkaccessories.com. For best results, prepare your home as indicated below, and schedule a daily cleaning to ensure all floor areas are regularly maintained.

NOTE: Scheduling is one of many features that are only available in the app.

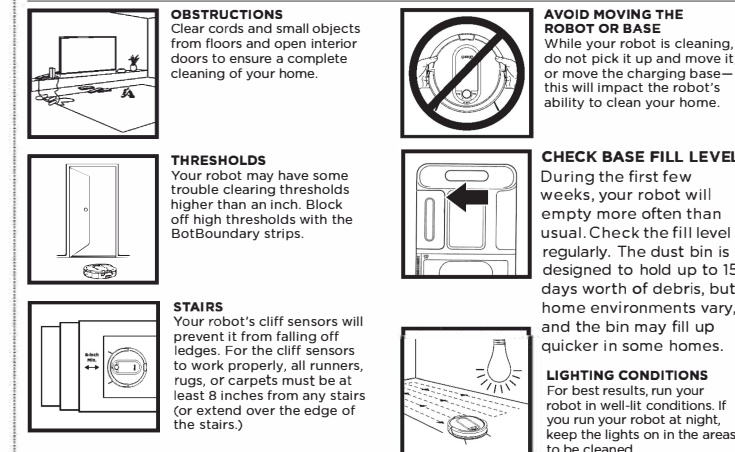

Note: The BotBoundary strips are not supplied. Sold separately.

MANUAL CLEANING MODE

To manually start a cleaning cycle, press the **Clean** button on the robot or on the mobile app. To stop the robot before it finishes cleaning and automatically returns to the base, press the **Dock** button.

NOTE: Be sure to charge the robot completely before its first cleaning so that it can explore and clean as much of your home as possible. It may take up to 6 hours to fully charge the robot.

NOTE: Avoid picking up and moving the robot or base. If either are relocated, the robot may not be able to follow its intelligent cleaning path, or find its way back to the base. If the robot is picked up or moved for any reason, it should be returned to within 6 inches of its last location.

USING THE SHARK™ EZ ROBOT

USING THE SHARKCLEAN™ APP AND VOICE CONTROLS

Get the most out of your Shark™ EZ Robot with these app features:

- Recharge and Resume**
Your robot will return to the dock, recharge, and can pick up cleaning where it left off.
- Scheduling**
Set whole home cleanings for any time, any day.
- Control From Anywhere**
Wherever you are, you're in control of your robot.
- Cleaning Reports**
Each time your robot cleans, your app will generate a cleaning report.
- Volume Control**
You can adjust the volume level of your robot's audio notifications.

Search for SharkClean in the app store and download the app to your iPhone or Android.

SETTING UP VOICE CONTROL WITH THE GOOGLE ASSISTANT OR AMAZON ALEXA

Visit sharkclean.com/app for setup instructions which include how to enable Shark Skill for Amazon Alexa and using with Google Assistant.



Google Assistant:

"OK Google, tell Shark to start cleaning." "OK Google, tell Shark to pause my robot." "OK Google, tell Shark to send my robot to the dock."

Amazon Alexa:

"Alexa, tell Shark to start cleaning." "Alexa, tell Shark to pause my robot." "Alexa, tell Shark to send my robot to the dock."

WI-FI TROUBLESHOOTING

- To use the app, your phone must be connected to a **2.4 GHz** network. The app will only work on a 2.4 GHz network.
- Typical home Wi-Fi networks support both **2.4 GHz** and **5 GHz**.
- Do not use a VPN or a proxy server.
- Make sure Wi-Fi isolation is turned off on the router.
- If you cannot connect, contact a service center.

STILL CAN'T CONNECT?

- Turn off phone, wait a few minutes, then turn it back on and connect to Wi-Fi.
- Reboot your robot**
- Make sure the power switch on the back of the BASE is in the ON position.
- Press the power switch on the side of the ROBOT to the OFF position. Wait 10 seconds, then press it again to turn power back ON.

Reboot your router

- Unplug the router power cable for 30 seconds, then plug it back in. Allow several minutes for your router to reboot completely.

ERROR CODE	PROBLEM
! (RED) + Wi-Fi indicator (RED Flashing)	Wrong password for Wi-Fi
! (Flashing red) + Wi-Fi (RED)	SSID cannot be found, try connecting again
! + Wi-Fi (Flashing RED alternately)	Wrong user name or password for your Shark account
! + Wi-Fi (Flashing RED at the same time)	Cannot connect to Wi-Fi

MAINTENANCE

CAUTION: Turn off power before performing any maintenance.

EMPTYING THE ROBOT DUST BIN

- Press the Dust Bin Release Tabs and slide out the dust bin.
- To avoid spills, be sure to hold the dust bin in an upright position. Pinch and lift to open the lid.
- Empty debris and dust into trash.
- Look between the filter and plastic shield and make sure there is no debris buildup. Remove and clean any debris build-up as needed with a dry cloth or soft brush.

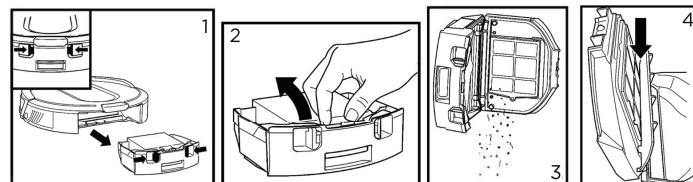

EMPTYING THE BASE DUST BIN

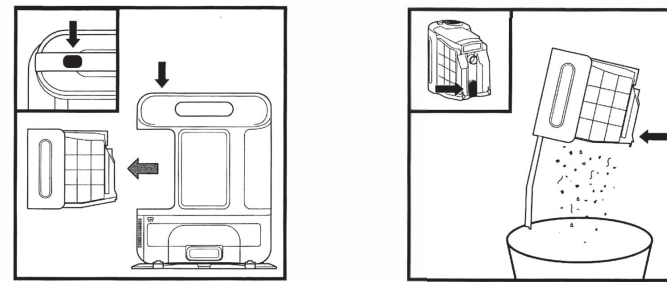

The **Base Dust Bin** holds up to 30 days' worth of dust and debris. Empty the bin when the debris level approaches the max fill line.

To detach it, press the **Release** button on top of the handle, then slide out the bin.

To empty the bin, hold it over a trash can and press the **Empty** button on the side.

CLEANING AND REPLACING THE FILTER

For optimal suction power, regularly clean and replace the filter inside the robot's dust bin. **IMPORTANT: DO NOT** use water when cleaning the filter.

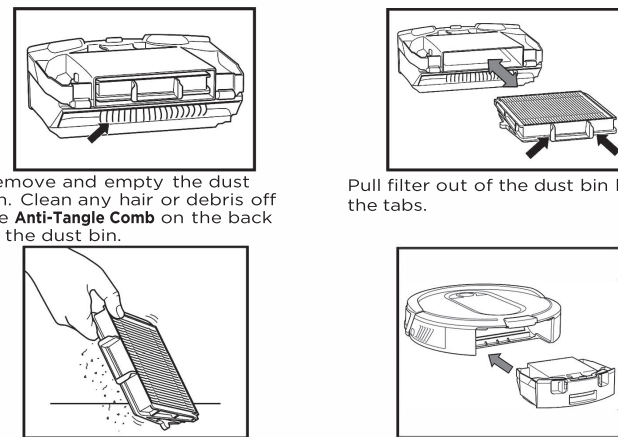

Remove and empty the dust bin. Clean any hair or debris off the **Anti-Tangle Comb** on the back of the dust bin.

Pull filter out of the dust bin by the tabs.

Lightly tap the filter to remove dust and debris.

Reinsert the filter into the dust bin, then slide the dust bin back into the robot.

NOTE: Make sure to insert the dust bin completely, until it clicks into place.

CLEANING AND REPLACING THE BASE FILTERS

For best results, regularly clean and replace the filters in the base. To clean filters, rinse with cold water **ONLY** to prevent damage from cleaning chemicals. Allow all filters to air-dry for at least 24 hours before reinstalling them to prevent liquid from being drawn into electric parts.

IMPORTANT- DO NOT use soap when cleaning the filters.

1. CLEAN PRE-MOTOR FILTERS ONCE A MONTH

To access the pre-motor filters, remove the cover on the side of the base. Press both slots at the same time and pull off the cover. Lift out the foam filter by the handle, and then remove the felt filter underneath. Tap the filters clean over the trash, then rinse them with cold water only, as soap or other cleaners may damage them. Allow the filters to air-dry for 24 hours before reinstalling.

The filters must be installed correctly for the base to work properly. Reinsert the felt filter first, then the foam filter. To reattach the cover, align the bottom of the cover with the slot on the base and press firmly until it clicks into place.

2. CLEAN POST-MOTOR FILTER EVERY YEAR

Press the button at the top of the **Filter Door**, then tilt the door and lift it off. Remove the **Post-Motor Filter** from the base. To reinstall the post-motor filter, insert it into the base and replace the filter door.

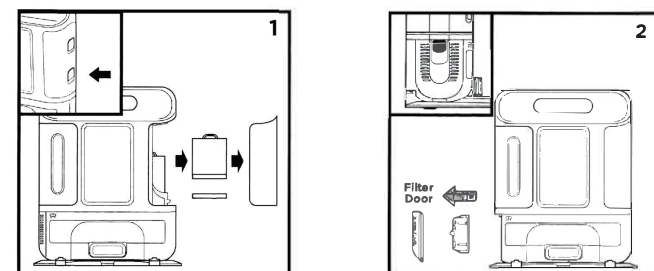

SELF-CLEANING BRUSHROLL

If some debris remains wrapped around the brushroll, continue cleaning to allow the brushroll to clean itself. To manually clean the brushroll, follow the below steps:

- To access the brushroll, push up on the tabs on the brushroll access door, then lift off the door.
- Lift out the brushroll, and clean off any debris. Reinstall the brushroll, inserting the flat end first. Close the brushroll access door and press down until both sides click into place.

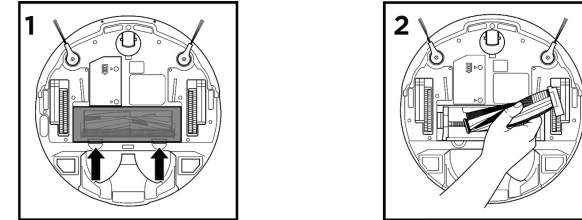

NOTE: When cutting away debris, be sure not to cut the brushroll.

NOTE: Replace brushroll every 6 to 12 months, or when visibly worn.

CLEANING THE WHEELS

REMOVE AND CLEAN THE FRONT CASTER WHEEL AS NEEDED.

- Pull the **Front Caster Wheel** from its housing and remove any debris buildup.
- Clean the wheel housing, then reinsert the caster wheel.
- Periodically clean the drive wheels and the housing around them. To clean, rotate each drive wheel while dusting.

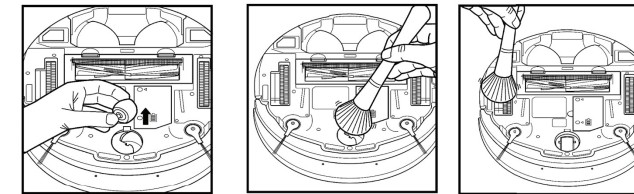

NOTE: Tools may be required to pry off front caster wheel.

NOTE: Brush not included.

MAINTENANCE

CAUTION: Turn off power before performing any maintenance.

TROUBLESHOOTING

If any error lights are illuminated or flashing on your Shark® EZ Robot, see the error code chart below:

ERROR CODE	ERROR NUMBER	SOLUTION
CLEAN (RED) flashing	10	Robot may be stuck on an obstacle. Move robot to a new location on a level surface.
DOCK (RED) flashing	6	Front bumper may be jammed. Clean the bumper and make sure it moves in and out freely. If the issue persists, please contact a service center.
CLEAN (RED)+ DOCK (BLUE) flashing	7	Cliff sensor error. Move your robot to a new location and clean its cliff sensors.
CLEAN (RED)+ DOCK (RED) flashing	9	Robot dust bin needs to be reinstalled. Insert the dust bin until it clicks in place.
DOCK (RED) + ! (RED) flashing	2	Robot's side brush got stuck while trying to clean. Remove any debris from around the side brushes. If the issue persists, please contact a service center.
CLEAN (RED)+ DOCK (RED) + ! (RED) flashing	2	A drive wheel is stuck. Clean the wheels and remove any debris wrapped around the axles so they can move freely.
CLEAN (RED)+ DOCK (BLUE) alternating	16	Robot is stuck. Move your robot to a new location and make sure the front bumper moves in and out freely.
CLEAN (RED) + (RED) flashing	2	Robot's brushroll got stuck while trying to clean. Remove any debris from the brushroll by removing the brushroll access door and checking inside and around the brushroll for any items that are stuck.
CLEAN (RED)+ DOCK (BLUE) + ! (RED) flashing	21	Robot has encountered an error while booting. Please turn the power off and back on.
CLEAN (BLUE)+ DOCK (RED) flashing	23	Make sure your base indicator light turns blue to confirm your robot is placed on the base correctly.

BATTERYCON (RED) flashing	24	Battery is critically low and needs recharging. Please pick up your robot and place it on the base. Make sure the base indicator light turns blue to confirm your robot is placed on the base correctly.
CLEAN (RED)+! (RED) alternating	2	Blockage in brushroll. Remove any debris from around the brushroll so that it can spin freely.
DOCK (RED) FLASHING +! (RED) solid	26	Blockage in dust bin. Check base and robot dust bin for clogs. Clear any debris and reinstall the dust bin, ensuring that it clicks into place.
DOCK (BLUE) + (RED) flashing	24	Robot has encountered an error while charging. Please make sure you are using the correct power cord for the base.
CLEAN (RED)+ (RED) flashing	3	Suction motor failure. Remove and empty the dust bin, clean the filters, and remove blockages.
CLEAN (BLUE)+ DOCK (RED) + ! (RED) flashing	2	Wheel motor encoder failure. Please contact a Service Center.

For all other issues, please call a Service Center.

REFURBISHED PRODUCT LIMITED NINETY DAYS WARRANTY

The **Refurbished Product Service Center** offers the following WARRANTY to the ORIGINAL purchaser of a product which we have refurbished.

This product that has been refurbished is warranted against any electronic or mechanical defects for a period of NINETY DAYS from the date of the original purchase by the consumer. Since this unit was sold as a refurbished item, the warranty does not apply to any cosmetic appearance items such as scratches. Should a defect occur, the **Refurbished Product Service Center** will repair or, at its option, replace defective unit/parts with new or rebuilt materials without charge for either parts or labor. Replacement unit/parts will be warranted for the remaining portion of the original warranty period.

This warranty does not cover installation or damage from accident, misuse, abuse, improper wiring, incorrect voltage, operating the unit against the instructions in the owner's manual or any product which has been opened, altered, or tampered with.

This warranty does not cover costs for removal and or installation of the unit for repair. Under no circumstances shall the service center be liable for any special, incidental or consequential damages or for any other expenses incurred by reason of use or sale of this product. This warranty is in lieu of any other warranties expressed or implied warranty of merchantability of fitness for particular use or otherwise.

This warranty gives the consumer specific legal rights and they may also have other rights which vary from State to State. Some States do not follow the exclusion or limitation of incidental or consequential damages, hence the above exclusion and limitations may not apply.

Refurbished Product Service Center

9043 Siempre Viva Rd Suite 110/120, San Diego CA, 92154

WARRANTY REPAIR INFORMATION

If you need service on your unit and this product requires repair during the 90 days warranty period; please go to www.ConsumerServiceRefurbish.com or call the **Refurbished Product Service Center** at 562-946-3531 to obtain the required return authorization (RA) number. Pack the unit properly (the original carton is ideal for this purpose) along with a copy of your purchase receipt and a letter describing the problem. Send the unit freight prepaid and insured to:

Refurbished Product Service Center,

Att: Customer Service Department 9043 Siempre Viva Rd Suite 110/120, San Diego CA, 92154

Your unit will be promptly repaired and returned to you.

We will refuse to accept delivery of the returned unit unless the assigned RA number appears on the outside of the shipping carton.

Owner's Information

(Keep for your permanent records)

NAME: _____

ADDRESS: _____

CITY: _____ STATE: _____ ZIP CODE: _____

PHONE: _____ E-MAIL: _____

MODEL: _____ SERIAL NO.: _____



804106797



PRINTED IN MEXICO SC: 05-13-2022_TAB MODEL: RV913A1US_B
OBPN: 900AE_SERIES_IB_MP_MV7_210616 Elbrd: M.C