

IMPORTANT SAFETY INSTRUCTIONS PLEASE READ CAREFULLY BEFORE USE • FOR HOUSEHOLD USE ONLY

If the charging cable plug does not fit fully into the outlet, reverse the plug. If it still does not fit, contact a qualified electrician. **DO NOT** force into outlet or try to modify to fit.

WARNING

To reduce the risk of fire, electric shock, injury, or property damage:

GENERAL WARNINGS

When using an electrical appliance, basic precautions should always be followed, including the following:

1. Robotic vacuum cleaner consists of a robotic vacuum and charging dock with power supply. These components contain electrical connections, electrical wiring, and moving parts that potentially present risk to the user.
2. Before each use, carefully inspect all parts for any damage. If a part is damaged, discontinue use.
3. Use only identical replacement parts.
4. This robotic vacuum cleaner contains no serviceable parts.
5. Use only as described in this manual. **DO NOT** use the robotic vacuum cleaner for any purpose other than those described in this manual.
6. With the exception of filters, **DO NOT** expose any parts of the robotic vacuum cleaner to water or other liquids.

USE WARNINGS

7. This appliance can be used by persons with reduced physical, sensory or mental capabilities or lack of experience and knowledge if they have been given supervision or instruction concerning use of the appliance in a safe way and understand the hazards involved.
 - a) Children shall not play with the appliance.
 - b) Cleaning and user maintenance shall not be made by children without supervision.
8. Be sure bot boundaries completely enclose desired areas. Gaps may cause bot boundaries to malfunction.
9. Always turn off the robotic vacuum cleaner before inserting or removing the filter or dust bin.
10. **DO NOT** handle plug, charging dock, charging cable, or robotic vacuum cleaner with wet hands. Cleaning and user maintenance shall not be made by children without supervision.
11. **DO NOT** use without robot dust bin and filters in place.
12. **DO NOT** damage the charging cord:
 - a) **DO NOT** pull or carry charging dock by the cord or use the cord as a handle.
 - b) **DO NOT** unplug by pulling on cord. Grasp the plug, not the cord.
 - c) **DO NOT** close a door on the cord, pull the cord around sharp corners, or leave the cord near heated surfaces.
13. **DO NOT** put any objects into nozzle or accessory openings. **DO NOT** use with any opening blocked; keep free of dust, lint, hair, and anything that may reduce airflow.
14. **DO NOT** use if robotic vacuum cleaner airflow is restricted. If the air paths become blocked, turn the vacuum cleaner off and remove all obstructions before turning on the unit again.
15. Keep nozzle and all vacuum openings away from hair, face, fingers, uncovered feet, or loose clothing.
16. **DO NOT** use if robotic vacuum cleaner is not working as it should, or has been dropped, damaged, left outdoors, or dropped into water.
17. **DO NOT** place vacuum cleaner on unstable surfaces.
18. **DO NOT** use to pick up:
 - a) Liquids
 - b) Large objects
 - c) Hard or sharp objects (glass, nails, screws, or coins)
 - d) Large quantities of dust (drywall dust, fireplace ash, or ember)
 - e) **DO NOT** use as an attachment to power tools for dust collection.
 - f) Smoking or burning objects (hot coals, cigarette butts, or matches)
 - g) Flammable or combustible materials (lighter fluid, gasoline, or kerosene)
 - h) Toxic materials (chlorine bleach, ammonia, or drain cleaner)
19. **DO NOT** use in the following areas:
 - a) Wet or damp surfaces
 - b) Outdoor areas near fireplaces with unobstructed entrances
 - c) Spaces that are enclosed and may contain explosive or toxic fumes or vapors (lighter fluid, gasoline, kerosene, paint, paint thinners, mothproofing substances, or flammable dust)
 - d) In an area with a space heater
 - e) Near fireplaces with unobstructed entrances
20. Turn off the robotic vacuum cleaner before any adjustment, cleaning, maintenance or troubleshooting.
21. Allow all filters to air-dry completely before replacing in the robotic vacuum cleaner to prevent liquid from being drawn into electric parts.
22. **DO NOT** modify or attempt to repair the robotic vacuum cleaner or the battery yourself, except as indicated in this manual. **DO NOT** use the vacuum if it has been modified or damaged.

BATTERY USE

23. The battery is the power source for the vacuum. Carefully read and follow all charging instructions.
24. To prevent unintentional starting, ensure the vacuum is powered off before picking up or carrying the vacuum. **DO NOT** carry the appliance with your finger on the power switch.
25. Use **ONLY** the Shark® charging dock and use only battery. Use of batteries or battery chargers other than those indicated may create a risk of fire.
26. Keep the battery away from all metal objects such as paper clips, coins, keys, nails, or screws. Shorting the battery terminals together increases the risk of fire or burns.
27. Do **NOT** place BotBoundary strips on top of one another.
28. Under abusive conditions, liquids may be ejected from the battery. Avoid contact with this liquid, as it may cause irritation or burns. If contact occurs, flush with water. If liquid contacts eyes, seek medical help.
29. Robotic vacuum cleaner should not be stored, charged, or used at temperatures below 50°F (10°C) or above 104°F (40°C). Ensure the battery and vacuum have reached room temperature before charging or use. Exposing the robot or battery to temperatures outside of this range may damage the battery and increase the risk of fire.
30. **DO NOT** expose the robotic vacuum cleaner or battery to fire or temperatures above 265°F (130°C) as it may cause explosion.

BOTBOUNDARY® STRIPS

31. **DO NOT** put BotBoundary strips underneath carpet or rugs.
32. **DO NOT** place BotBoundary strips on top of one another.
33. Always use BotBoundary strips around reflective flooring and surfaces.
34. BotBoundary strips should always be used near carpeted stairs.
35. **DO NOT** place BotBoundary strips within 10 feet of the dock.
36. For your robot's cliff sensors to work properly, all runners, rugs, or carpets must be eight inches from any stairs (or it must be continuous and extend over the edge of the stairs). If a runner, rug or carpet edge that is less than eight inches from the stairs cannot be moved, you must use a BotBoundary strip to block off the stairs.

GETTING TO KNOW YOUR SHARK IQ ROBOT®

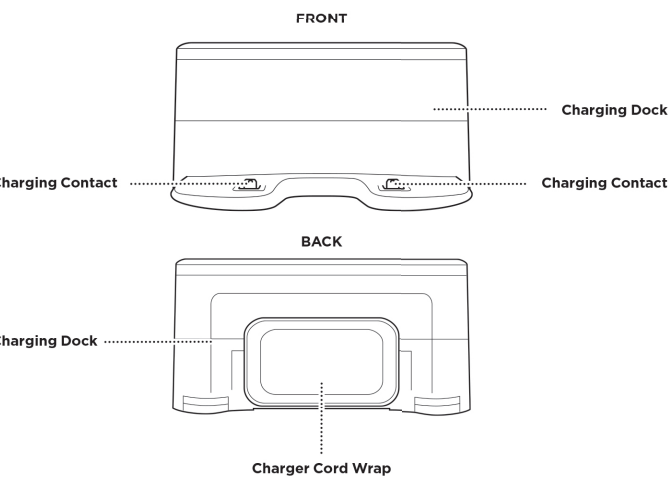
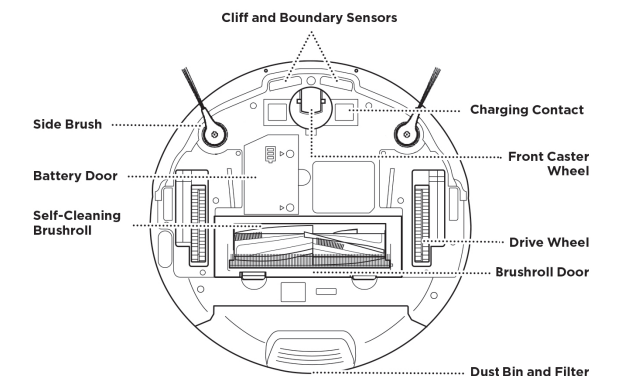
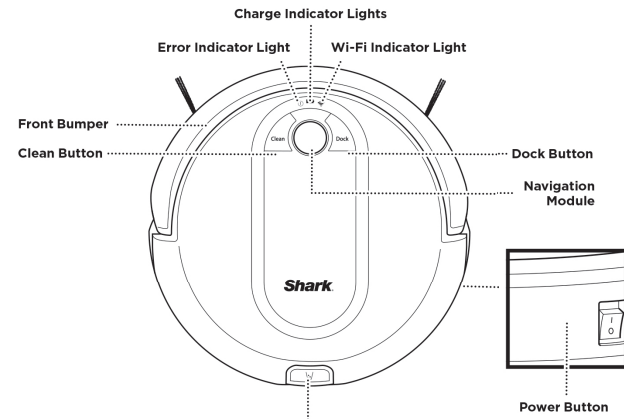

Note: The Quick Guide shows the select accessories that are included with your model.

Accessory type and quantity may vary depending on the model.

The image shown here is for illustrative purposes only and may be subject to change.

Illustrations may differ from actual product. We are constantly striving to improve our products; therefore the specifications contained herein are subject to change without notice.



DOCK SETUP

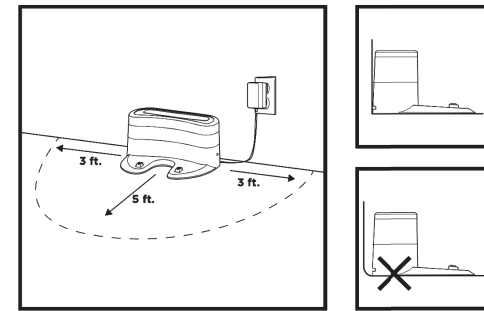

NOTE: Select a permanent location for the Charging Dock.

NOTE: For best results, set up on hard floor or thin carpet.

NOTE: Do not place dock against baseboards, heating elements, or in direct sunlight.

Choose a level surface in a central area. Remove any objects that are closer than 3 feet from either side of the dock, or closer than 5 feet from the front of the dock. Place the dock with its back against the wall. Plug the charging cord into an outlet. The indicator light on the dock will illuminate green when the dock has power. The dock must be plugged in continuously for the robot to find it.

INSTALLING THE SIDE BRUSHES

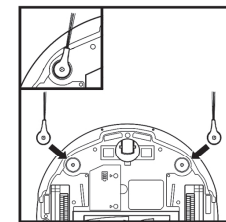

Snap the 2 included **Side Brushes** onto the square pegs on the bottom of the robot.

CHARGING

IMPORTANT: The Shark IQ Robot™ has a pre-installed rechargeable battery. Battery should be fully charged before using. It may take up to 6 hours to fully charge.

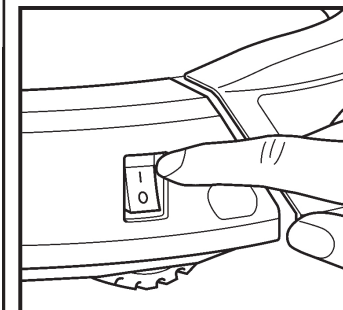

To charge, the **Power** button on the side of the robot is running low, the robot will beep when charging begins.

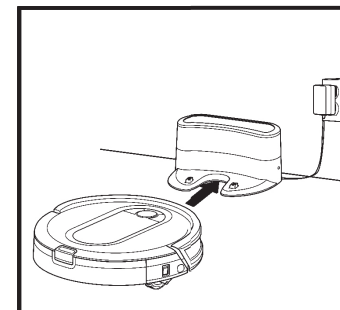

When the cleaning cycle is complete, or if the battery is running low, the robot will search for the dock. If your robot doesn't return to the dock, its charge may have run out.

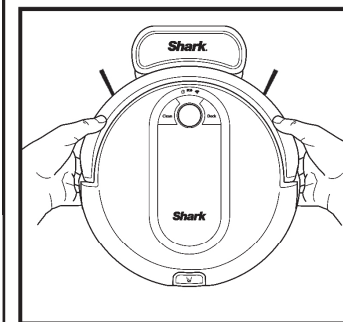

If the robot has no charge and cannot return to the dock, manually place it on the dock. The dock indicator light will flash blue and the robot will beep when charging begins.

NOTE: When manually placing the robot on the dock, make sure the **Charging Contacts** on the bottom of the robot are touching the ones on the dock. While the robot is charging, both blue LED lights will flash. When charging is complete, both blue lights will illuminate steadily.

NOTE: When picking up the robot, be careful not to place fingers between the bumper and the base of the robot.

CHARGE INDICATOR LIGHTS

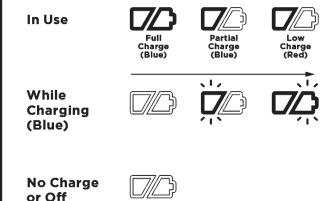
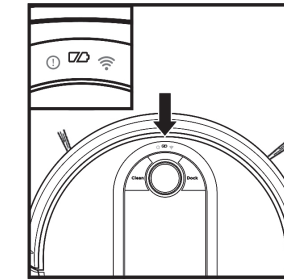

The blue indicator lights on the robot show how much charge is remaining. While the robot is charging, both blue LED lights will flash. When charging is complete, both blue lights will illuminate steadily. It may take up to 6 hours to fully charge your robot.

NOTE: If the low charge light is blinking red, there is not enough charge for the robot to return to the dock. Manually place the robot on the dock.

BUTTONS AND INDICATOR LIGHTS

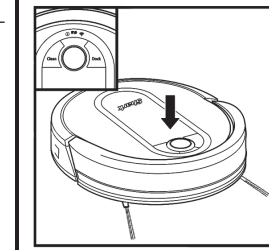

CLEAN BUTTON
Press to begin a cleaning session. Press again to stop.

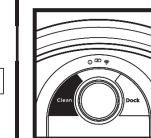

RECHARGE & RESUME
Press and hold the **CLEAN** button for 15 seconds to turn Recharge & Resume ON or OFF.

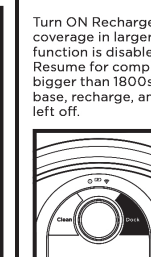

DOCK BUTTON
Press to stop cleaning and send robot back to the charging dock.



CHARGE INDICATOR LIGHTS
Display the amount of charge remaining in the battery.



#1 ERROR INDICATOR
See Troubleshooting section for full list of error codes.



WI-FI INDICATOR
Blue light: connected to Wi-Fi.
Red light: not connected.
Flashing blue: setup mode.
No light: not set up yet.

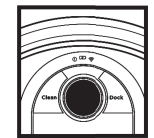

NAVIGATION MODULE
Please keep clear and do not cover.
Upward facing sensor aids advanced navigation.

PREP YOUR HOME

Your robot uses an array of sensors to navigate around walls, furniture legs, and other obstacles while it cleans. To prevent the robot from bumping into objects or navigating to areas you don't want it to, use the included BotBoundary® strips. For best results, prepare your home as indicated below, and schedule a daily cleaning to ensure all floor areas are regularly maintained.

NOTE: scheduling can only be done in the app.

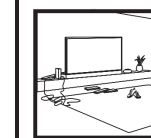

OBSTRUCTIONS
Clear cords and small objects from floors and open doors to ensure a complete clean of your home.

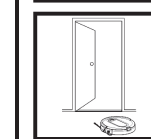

THRESHOLDS
Your robot may have some trouble clearing some high thresholds higher than 7/8ths of an inch. Block off high thresholds with the included BotBoundary® strips.

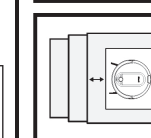

STAIRS
Your robot's cliff sensors will prevent it from falling off ledges. For your robot's cliff sensors to work properly, all runners, rugs, or carpets must be at least 8 inches from any stairs (or extend over the edge of the stairs.)



SCHEDULING
For a constant state of clean, set up a cleaning schedule in the app.



AVOID MOVING THE ROBOT & DOCK
While your robot is cleaning, do not pick it up and move it to different rooms, or move the charging dock—this could impact the robot's navigation.

IMPORTANT: Before cleaning an entire room for the first time, we recommend that you first test your robot on a small section of the floor to ensure there is no scratching.

MANUAL CLEANING MODE

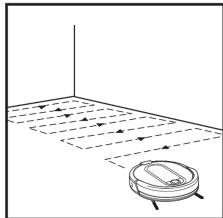

To manually start a cleaning cycle, press the **Clean** button on the robot or on the mobile app. To stop the robot before it finishes cleaning and automatically returns to the dock, press the Dock button.

NOTE: Be sure to charge the robot completely before its first cleaning so that it can explore, and clean as much of your home as possible. It may take up to 6 hours to fully charge your robot.

NOTE: Avoid picking up or moving the robot or dock. If either are relocated, the robot may not be able to follow its intelligent cleaning path, or find its way back to the dock. If the robot is picked up or moved for any reason, it should be returned to within 6 inches of its last location.

USING THE SHARK IQ ROBOT®

USING THE SHARKCLEAN™ APP AND VOICE CONTROLS

Get the most out of your Shark IQ Robot® with these app features:

- **Recharge and Resume**
Use Recharge and Resume to help ensure complete, multi-room coverage in your home.



- **Scheduling**
Set whole-home cleanings for any time, any day.
- **Control From Anywhere**
Wherever you are, you're in control of your robot.
- **Cleaning Reports**
Each time your robot cleans, your app will generate a cleaning report.
- **Volume Control**
You can adjust the volume level of your robot's audio notifications.

Search for **SharkClean** in the app store and download the app to your iPhone™ or Android™.



SETTING UP VOICE CONTROL WITH THE GOOGLE ASSISTANT OR AMAZON ALEXA

Visit sharkclean.com/app for setup instructions which include how to enable Shark Skill for Amazon Alexa and using with Google Assistant.

Google Assistant:

"OK Google, tell Shark to start cleaning."
"OK Google, tell Shark to pause my robot."
"OK Google, tell Shark to send my robot to the dock."

Amazon Alexa:

"Alexa, tell Shark to start cleaning."
"Alexa, tell Shark to pause my robot."
"Alexa, tell Shark to send my robot to the dock."

WI-FI TROUBLESHOOTING

- To use the app, your phone must be connected to a **2.4GHz** network. The app will only work on a 2.4GHz network.
- Typical home Wi-Fi networks support both 2.4GHz and 5GHz.
- Do not use a VPN or a proxy server.
- Make sure Wi-Fi isolation is turned off on the router.
- If you cannot connect, call a service center

STILL CAN'T CONNECT?

- **Restart your phone**
Reboot your robot
• Press the power button on the side of the ROBOT to the OFF position, for 10 seconds then press it again to turn power back ON.
- **Reboot your router**
• Unplug the router power cable for 30 seconds, then plug it back in. Allow several minutes for your router to reboot completely.

ERROR CODE	PROBLEM
! (RED) + Wi-Fi Indicator (RED Flashing)	Wrong password for Wi-Fi
! (Flashing red) + Wi-Fi (RED)	SSID cannot be found, try connecting again
! + Wi-Fi (Flashing RED alternately)	Wrong user name or password for your Shark account
! + Wi-Fi (Flashing RED at the same time)	Cannot connect to Wi-Fi

MAINTENANCE



CAUTION: Turn off power before performing any maintenance.

EMPTYING THE DUST BIN

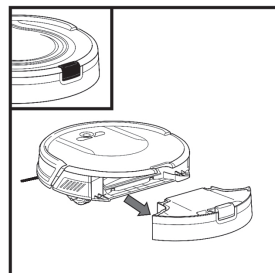

Press the **Dust Bin Release Tab** and slide out the dust bin.

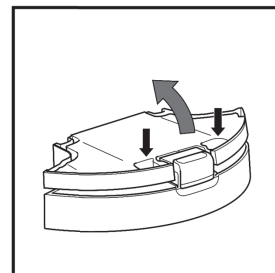

To avoid spills, be sure to hold the dust bin in an upright position. Use the finger slots to open the lid.

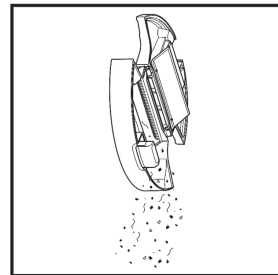

Empty debris and dust into trash.

NOTE: Make sure to insert the dust bin completely, until it clicks into place.

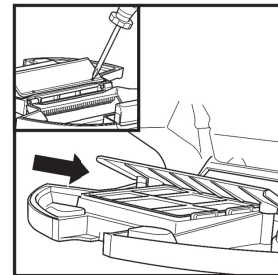

Look between the filter and plastic shield and make sure there is no debris buildup. Remove shield and clear any debris buildup as needed with a dry cloth or soft brush.

CLEANING AND REPLACING THE FILTER

For optimal suction power, regularly clean and replace the filter inside the robot's dust bin.

IMPORTANT: DO NOT use water when cleaning the filter.

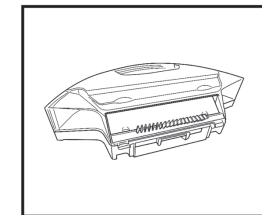

Remove and empty the dust bin. Clean any hair or debris off the **Anti-Tangle Comb** on the back of the dust bin.

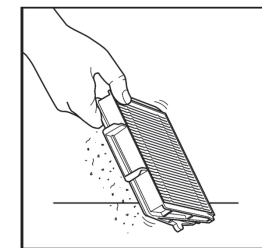

Lightly tap the filter to remove dust and debris.

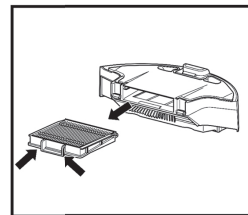

Pull filter out of the dust bin by the tabs.

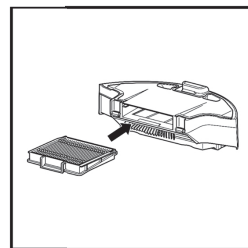

Reinsert the filter into the dust bin, then slide the dust bin back into the robot.

NOTE: Make sure to insert the dust bin completely, until it clicks into place.

SELF-CLEANING BRUSHROLL

The **Self-Cleaning Brushroll** actively removes hair wrap while your robot cleans. If some debris remains wrapped around the brushroll, continue cleaning to allow the brushroll to clean itself.

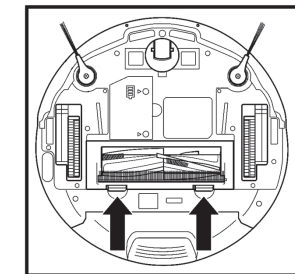

To access the brushroll, push up on the tabs on the brushroll access door, then lift off the door.

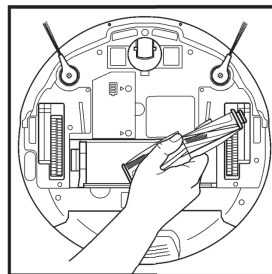

Lift out the brushroll. Clean off any debris from the brush roll. Reinstall the brushroll, inserting the flat end first. Close the brushroll access door and press down until both sides click into place.

NOTE: Replace brushroll every 6 to 12 months, or when visibly worn.
NOTE: When cutting away debris, be sure not to cut the brushroll.

Illustrations may differ from actual product. We are constantly striving to improve our products; therefore the specifications contained herein are subject to change without notice.

CLEANING SENSORS AND CHARGING PADS

CLEAN SENSORS AND CHARGING PADS AS NEEDED. With a dry cloth, gently dust off the sensors and pads located on the bottom of the robot and on the dock.

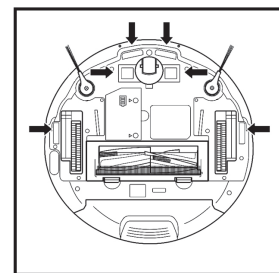

IMPORTANT: The robot uses cliff sensors to avoid stairs and other steep drops. Sensors may work less effectively when they are dirty. For best results, clean sensors regularly.

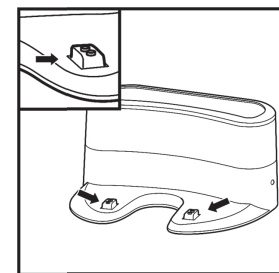

CLEANING SIDE BRUSHES

CLEAN SIDE BRUSHES AS NEEDED.

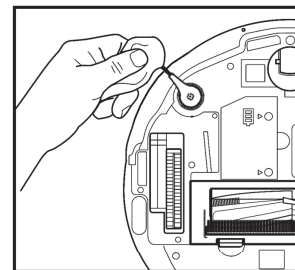

Carefully unwind and remove any string or hair wrapped around brushes. Gently wipe brushes with a dry cloth. To reinstall, snap the brushes over the pegs. Spin the brushes manually to make sure they are installed correctly.

NOTE: Remove and replace any side brushes that are bent or damaged. To remove a brush, lift it off its peg.

CLEANING THE WHEELS

CLEAN FRONT WHEEL PERIODICALLY.

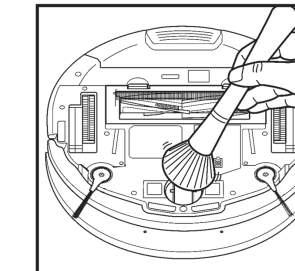

Clean the wheel housing.

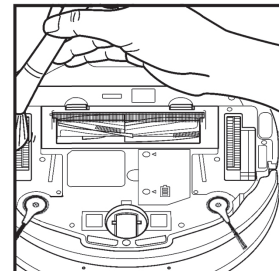

Periodically clean the drive wheels and the housing around them. To clean, rotate each drive wheel while dusting.

NOTE: Brush not included.

FCC WARNINGS

This equipment has been tested and found to comply with the limits for a Class B digital device, pursuant to parts 15 of the FCC Rules. These limits are designed to provide reasonable protection against harmful interference in a residential installation. This equipment generates, uses, and can radiate radio frequency energy and, if not installed and accordance with the instructions, may cause harmful interference to radio communications. However, there is no guarantee that interference will not occur in a particular installation. If this equipment does cause harmful interference to radio or television reception, which can be determined by turning the equipment off and on, the user is encouraged to try to correct the interference by one or more of the following measures:

- Reorient or relocate the receiving antenna.
- Increase the separation between the equipment and receiver.
- Connect the equipment into an outlet on a circuit different from that to which the receiver is connected.
- Consult the dealer or an experienced radio/TV technician for help.

This Device complies with part 15 of the FCC rules. Operation is subject to the following conditions:

- 1 This device may not cause harmful interference
 - 2 This device must accept any interference received, including interference that may cause undesired operation.
- Changes or modifications not expressly approved by the party responsible for compliance could void the user's authority to operate this device.

PLEASE READ CAREFULLY AND KEEP FOR FUTURE REFERENCE.

This Owner's Guide is designed to help you keep your Shark IQ Robot® running at peak performance. SharkNinja Operating LLC Illustrations may differ from actual product. We are constantly striving to improve our products; therefore the specifications contained herein are subject to change without notice.



CAUTION: Turn off power before performing any maintenance.

TROUBLESHOOTING

If any error lights are illuminated or flashing on your Shark IQ Robot™, see the error code chart below:

ERROR CODE	ERROR NUMBER	SOLUTION
CLEAN (RED) + ! (RED) flashing	3	Suction motor failure. Remove and empty the dust bin, clean the filters, and remove blockages to ensure nothing is reducing suction.
CLEAN (RED) flashing	10	Robot may be stuck on an obstacle. Move robot to a new location on a level surface.
DOCK (RED) flashing	6	Front bumper may be jammed. Clean the bumper and make sure it moves in and out freely.
CLEAN (BLUE) + DOCK (RED) solid	14	Rotational error. Move your robot to a flat surface away from the magnetic boundary strip and try cleaning again.
CLEAN (RED) + DOCK (BLUE) flashing	7	Cliff sensor error. Move your robot to a new location and clean its cliff sensors.
CLEAN (RED) + DOCK (RED) flashing	9	Robot dustbin has been removed and needs to be reinserted.
DOCK (RED) + ! (RED) flashing	2	Side brush is stuck. Remove any debris from around the side brushes.
CLEAN (RED) + DOCK (RED) + ! (RED) flashing	2	A drive wheel is stuck. Clean the wheels and remove any debris wrapped around the axles.
CLEAN (RED) + DOCK (BLUE) alternating	16	Robot is stuck. Move your robot to a new location and make sure the front bumper moves in and out freely.
CLEAN (BLUE) + DOCK (RED) + ! (RED) flashing	2	Wheel motor encoder failure. Please contact a service center.
CLEAN (BLUE) + ! (RED) flashing	2	Blockage in brushroll. Remove any debris from around the brushroll.
CLEAN (RED) + DOCK (BLUE) + ! (RED) flashing	21	Robot has encountered an error while booting. Please turn the power off and back on.
CLEAN (BLUE) + DOCK (RED) flashing	23	Robot cannot locate dock. Please pick up your robot and place it on the dock.
BATTERY ICON (RED) flashing	24	Battery is critically low and needs recharging. Power may be turned off or the battery may need charging.
CLEAN (RED) + ! (RED) alternating	2	Blockage in brushroll. Remove any debris from around the brushroll.

For all other issues, please call contact a service center.

REFURBISHED PRODUCT LIMITED NINETY DAYS WARRANTY

The **Refurbished Product Service Center** offers the following WARRANTY to the ORIGINAL purchaser of a product which we have refurbished.

This product that has been refurbished is warranted against any electronic or mechanical defects for a period of NINETY DAYS from the date of the original purchase by the consumer. Since this unit was sold as a refurbished item, the warranty does not apply to any cosmetic appearance items such as scratches. Should a defect occur, the **Refurbished Product Service Center** will repair or, at its option, replace defective unit/parts with new or rebuilt materials without charge for either parts or labor. Replacement unit/parts will be warranted for the remaining portion of the original warranty period.

This warranty does not cover installation or damage from accident, misuse, abuse, improper wiring, incorrect voltage, operating the unit against the instructions in the owner's manual or any product which has been opened, altered, or tampered with.

This warranty does not cover costs for removal and/or installation of the unit for repair. Under no circumstances shall the service center be liable for any special, incidental or consequential damages or for any other expenses incurred by reason of use or sale of this product. This warranty is in lieu of any other warranties expressed or implied warranty of merchantability of fitness for particular use or otherwise.

This warranty gives the consumer specific legal rights and they may also have other rights which vary from State to State. Some States do not follow the exclusion or limitation of incidental or consequential damages, hence the above exclusion and limitations may not apply.

Refurbished Product Service Center
9043 Siempre Viva Rd Suite 110/120, San Diego CA, 92154

WARRANTY REPAIR INFORMATION

If you need service on your unit and this product requires repair during the 90 days warranty period; please go to www.ConsumerServiceRefurbish.com or call the **Refurbished Product Service Center** at 562-946-3531 to obtain the required return authorization (RA) number. Pack the unit properly (the original carton is ideal for this purpose) along with a copy of your purchase receipt and a letter describing the problem. Send the unit freight prepaid and insured to:

Refurbished Product Service Center,
Attn: Customer Service Department 9043 Siempre Viva Rd Suite 110/120, San Diego CA, 92154

Your unit will be promptly repaired and returned to you. We will refuse to accept delivery of the returned unit unless the assigned RA number appears on the outside of the shipping carton.

Owner's Information
(Keep for your permanent records)

NAME: _____
ADDRESS: _____
CITY: _____ STATE: _____ ZIP CODE: _____
PHONE: _____ E-MAIL: _____
MODEL: _____ SERIAL NO.: _____



Printed in Mexico / Sc: 14-03-2022

804106727

Obpn:900Serie_IB_E_MP_Mv13_210729



Shmmdl: RV9904V3US_B / TAB