

# Shark Navigator®

## Lift-Away® Upright Vacuum with Self-Cleaning Brushroll

It's important to read this instruction book prior to using your new product for the first time.

### IMPORTANT SAFETY INSTRUCTIONS

#### HOUSEHOLD USE ONLY

To reduce the risk of electric shock, this vacuum cleaner has a polarized plug (one blade is wider than the other). As a safety feature, this plug will fit into a polarized outlet only one way. If the plug does not fit fully into the outlet, reverse the plug. If it still does not fit, contact a qualified electrician. **DO NOT** force into outlet or try to modify to fit.

#### WARNING

TO REDUCE THE RISK OF FIRE, ELECTRIC SHOCK OR INJURY:

#### GENERAL WARNINGS

When using an electrical appliance, basic precautions should always be followed, including the following:

1. Inspect power cord and plug for any damage before use. **DO NOT** use vacuum cleaner with a damaged cord or plug. Turn off all controls before plugging in or unplugging the vacuum cleaner. Store your vacuum cleaner with the power cord secured around the two cord hooks. To minimize the risk of power cord damage, do not allow the motorized brush roll to ingest the cord. If this occurs, immediately shut off power to the vacuum and remove the cord.
2. Your vacuum cleaner may consist of a motorized nozzle, wand, hose, and/or vacuum pod. This device contains electrical connections, electrical wiring, and moving parts that potentially present risk to the user.
3. Use only identical replacement parts.
4. Carefully observe and follow the instructions provided below to avoid improper use of the appliance. **DO NOT** use the vacuum for any purpose other than those described in this manual.
5. Before use, carefully inspect all parts for any damage. **DO NOT** use if any parts are damaged.
6. The use of an extension cord is **NOT** recommended.
7. This vacuum cleaner contains no serviceable parts.

#### USE WARNINGS

8. This appliance can be used by persons with reduced physical, sensory or mental capabilities or lack of experience and knowledge if they have been given supervision or instruction concerning use of the appliance in a safe way and understand the hazards involved. Cleaning and user maintenance shall not be made by children. Keep the appliance and its cord out of reach of children. **DO NOT** allow the appliance to be used by children. **DO NOT** allow to be used as a toy. Close supervision is necessary when used near children.
9. Always turn off the vacuum cleaner before connecting or disconnecting any motorized nozzles or other accessories.
10. **DO NOT** handle plug or vacuum cleaner with wet hands.
11. **DO NOT** use without filters in place.
12. Only use Shark® branded filters and accessories.
13. **DO NOT** damage the power cord:
  - a) **DO NOT** pull or carry vacuum cleaner by the cord or use the cord as a handle.
  - b) **DO NOT** unplug by pulling on cord. Grasp the plug, not the cord.
  - c) **DO NOT** run the vacuum cleaner over the power cord, close a door on the cord, pull the cord around sharp corners, or leave the cord near heated surfaces.
14. **DO NOT** put any objects into nozzle or accessory openings. **DO NOT** use with any opening blocked; keep free of dust, lint, hair, and anything that may reduce airflow.
15. **DO NOT** use if nozzle or accessory airflow is restricted. If the air paths or the motorized floor nozzle become blocked, turn the vacuum cleaner off and unplug from electrical outlet. Remove all obstructions before you plug in and turn on the unit again.

### OWNER'S GUIDE

804106580

16. Keep nozzle and all vacuum openings away from hair, face, fingers, uncovered feet, or loose clothing.
17. **DO NOT** use if vacuum cleaner is not working as it should, or has been dropped, damaged, left outdoors, or dropped into water.
18. Use extra care when cleaning on stairs.
19. **DO NOT** leave the vacuum cleaner unattended while plugged in.
20. When powered on, keep the vacuum cleaner moving over the carpet surface at all times to avoid damaging the carpet fibers.
21. **DO NOT** place vacuum cleaner on unstable surfaces such as chairs or tables.
22. Your Shark® vacuum may not be designed to stand up on its own. When taking a break from cleaning, you may need to lean it against furniture or a wall, or lay it flat on the floor. Using the vacuum for an application where the unit lacks stability may result in personal injury.
23. **DO NOT** use to pick up:
  - a) Liquids
  - b) Large objects
  - c) Hard or sharp objects (glass, nails, screws, or coins)
  - d) Large quantities of dust (drywall dust, fireplace ash, or embers). **DO NOT** use as an attachment to power tools for dust collection.
  - e) Smoking or burning objects (hot coals, cigarette butts, or matches)
  - f) Flammable or combustible materials (lighter fluid, gasoline, or kerosene)
  - g) Toxic materials (chlorine bleach, ammonia, or drain cleaner)
24. **DO NOT** use in the following areas:
  - a) Poorly lit areas
  - b) Wet or damp surfaces
  - c) Outdoor areas
  - d) Spaces that are enclosed and may contain explosive or toxic fumes or vapors (lighter fluid, gasoline, kerosene, paint, paint thinners, mothproofing substances, or flammable dust)
25. Turn off all controls before plugging in or unplugging the vacuum.
26. Unplug from electrical outlet when not in use and before any maintenance or cleaning.
27. Hand wash with water only. Washing with cleaning chemicals could damage the unit.
28. During cleaning or routine maintenance, **DO NOT** cut anything other than hair, fibers, or string wrapped around the brushroll.
29. Allow all filters to air-dry completely before replacing in the vacuum to prevent liquid from being drawn into electric parts.
30. Make sure the dust cup and all filters are in place after routine maintenance.
31. If provided, secure the power cord around the two cord hooks during storage.

#### TECHNICAL SPECIFICATIONS

Voltage: 120V- 60Hz

#### ASSEMBLY

**NOTE:** Accessories may vary depending on the model. Refer to quick guide, if available.

The images shown here are for illustrative purposes only and may be subject to change.

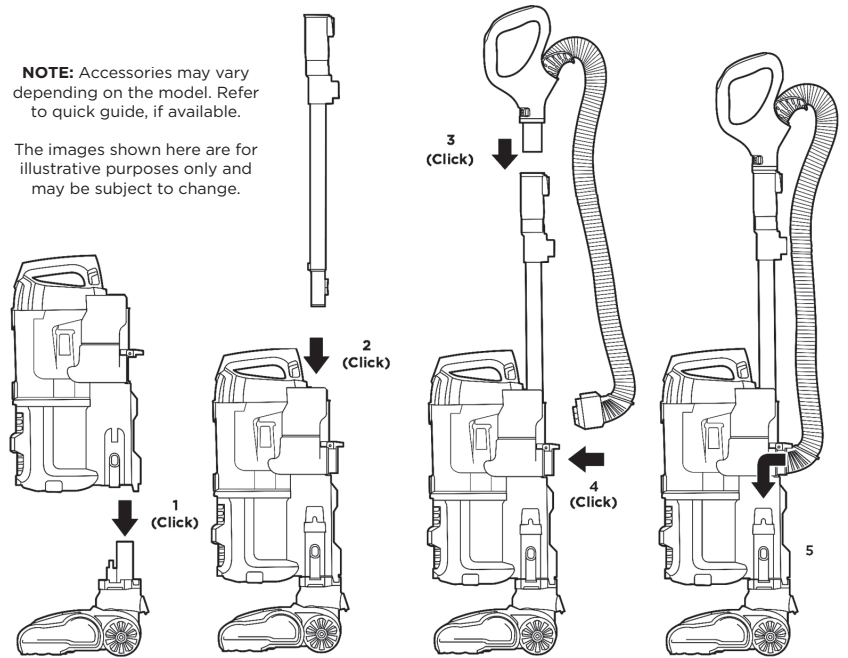

1. Place the **Pod** onto the **Floor Nozzle Post**.
2. Insert the **Wand** into the pod.
3. Insert the **Handle** into the top of the wand.
4. Connect the **Hose** to the back of the pod.
5. Store **Accessories** on the **Tool Storage Posts**.

For proper operation, please ensure that all parts are firmly pressed until **CLICKED** in place.

#### WHOLE-HOME CLEANING

##### SETTINGS

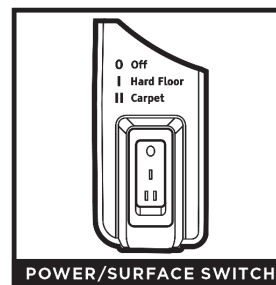

POWER/SURFACE SWITCH

Select surface setting:

- 0 Off**
- I Hard Floor**  
For bare floors and area rugs.
- II Carpet**  
For high pile carpets.

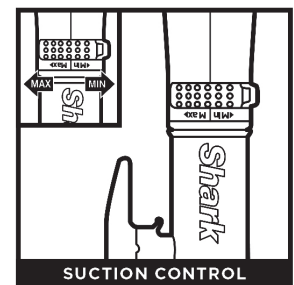

SUCTION CONTROL

The **Suction Control Slider** located on the handle allows you to adjust the suction depending on the floor type.

**MIN:** to reduce suction and increase maneuverability on carpets.  
**MAX:** to increase suction on bare floors.

**NOTE:** The brushroll spins in both modes.

#### BRUSHROLL INDICATOR LIGHT

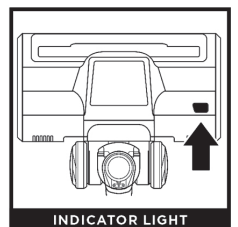

INDICATOR LIGHT

#### WHAT DOES THE BRUSHROLL INDICATOR LIGHT MEAN?

**Solid Green:** The brushroll is spinning and working as intended.

**Solid Red:** There is a jam in the brushroll area. Turn off the vacuum and unplug it, then remove any blockages in the nozzle.

**Flashing Red:** The motorized floor nozzle is overheating. Turn off the vacuum, unplug it, and remove any blockages. Let the vacuum cool down for at least 60 minutes before restarting. See Troubleshooting section for more information.

**NOTE:** For deep carpet cleaning per ASTM F608 (embedded dirt in carpets), set to **MAX** suction and use setting **II, Carpet**.

#### WHOLE-HOME CLEANING

##### CLEANING MODES

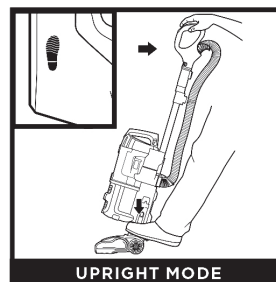

UPRIGHT MODE



ABOVE-FLOOR—HANDLE

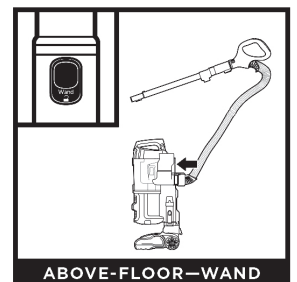

ABOVE-FLOOR—WAND

To engage **Brushroll**, step on floor nozzle and tilt handle back firmly. Press the Power/Surface switch to the appropriate floor setting.

Press the **Handle Release** button and pull up on the handle to detach it from the wand.

Press the **Wand Release** button and pull up on the wand to detach it from the pod.

In **Lift-Away** mode, you can clean with the handle and wand, or just the handle.

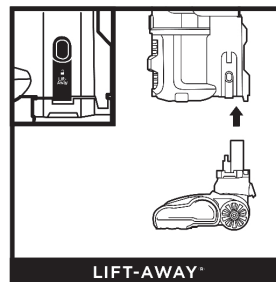

LIFT-AWAY®

Press the **Lift-Away** button to detach the pod from the floor nozzle.

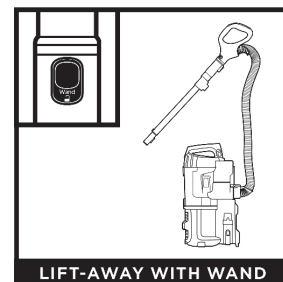

LIFT-AWAY WITH WAND

With pod removed, press the **Wand Release** button to detach the wand from the pod.

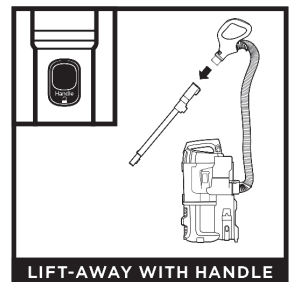

LIFT-AWAY WITH HANDLE

Press the **Handle Release** button and pull up on the handle to detach it from the wand.

**NOTE:** All accessories are compatible with both the wand and the handle.

**NOTE:** Accessories may vary depending on the model. Refer to quick guide, if available.

The images shown here are for illustrative purposes only and may be subject to change.

### SAVE THESE INSTRUCTIONS

READ ALL INSTRUCTIONS BEFORE USE

## EMPTYING THE DUST CUP



**IMPORTANT:** Unplug the power cord before performing any maintenance. Empty the dust cup each time you vacuum and periodically during cleaning, when debris in the dust cup reaches the MAX fill line.

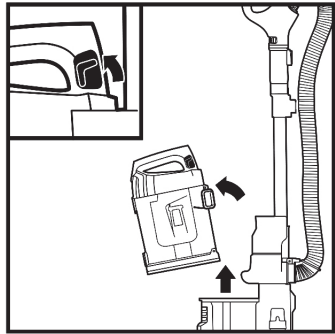

To remove **Dust Cup**, slide up tabs on both sides of dust cup handle. Tilt dust cup forward, then lift to remove.

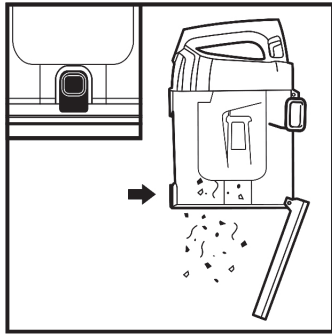

Press lower release button to open bottom of dust cup.

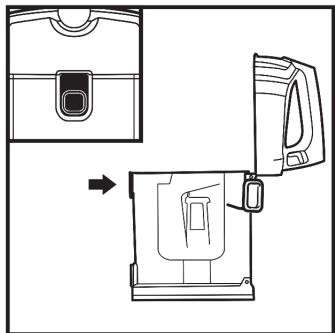

To remove collected debris from **Lint Screen**, press top release button and lift handle to open. Gently brush debris off the screen.

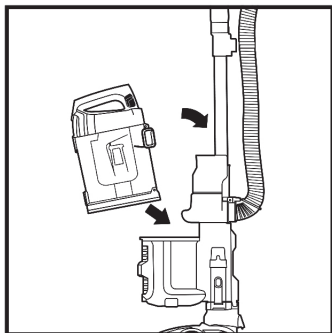

To reinstall, place bottom of dust cup into pod and then tilt until it clicks into place.

## CLEANING AND REPLACING THE FILTERS

### CLEANING FILTERS

**Regularly rinse and replace the filters to maintain your vacuum's suction power.**

To prevent damage from cleaning chemicals, rinse filters with cold water only. Allow all filters to air-dry for at least 24 hours before reinstalling them to prevent liquid from being drawn into electric parts.

**IMPORTANT: DO NOT** use soap when cleaning the filters.

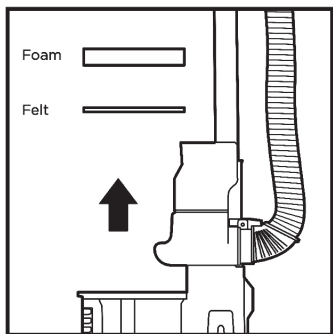

**CLEAN PRE-MOTOR FILTERS EVERY 3 MONTHS**

Remove **Dust Cup**, then lift out **Filters**.

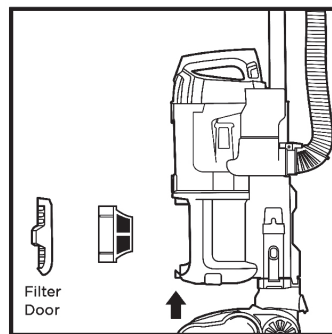

**RINSE HEPA FILTER EVERY YEAR**

To Remove **HEPA Filter**, remove dust cup, tilt **Filter Door** and firmly pull it off. Press tab at top of **HEPA Filter** and pull out filter.

To reinstall, insert top part of **HEPA filter** first. Then, replace filter door by inserting the top part with tabs first then pushing in bottom until it clicks into place.

## MAINTENANCE

### Self-Cleaning Brushroll

Shark's self-cleaning brushroll automatically removes hair wrap. If some hair remains wrapped around the brushroll, continue cleaning to give it time to make its way to the dust cup. If you run over a hard or sharp object or notice a noise change while vacuuming, check for blockages or objects caught behind the brushroll.

#### CLEANING THE BRUSHROLL

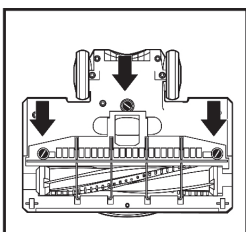

Using a coin, turn locks counterclockwise, then open the cover to access **Brushroll**.  
**NOTE:** Cover hinges open but is not completely removable.

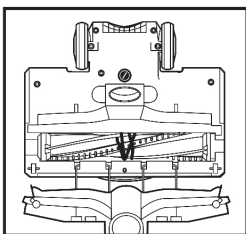
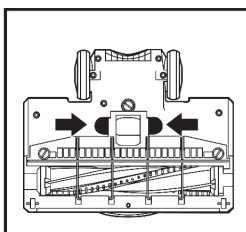

**DEBRIS WRAPPED AROUND BRUSHROLL**

Clean off any debris on the bristles.

**DEBRIS BEHIND BRUSHROLL**

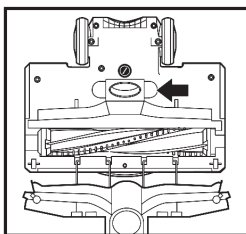

If you vacuum up a **hard** or **sharp** object, or notice a noise change while vacuuming, remove any blockages or objects caught behind the brushroll.

Clear away any dust, dirt, or blockages in **Debris Intake**.

To close the cover, push down until it clicks into place, then close the locks with a coin.

#### CORD MAINTENANCE

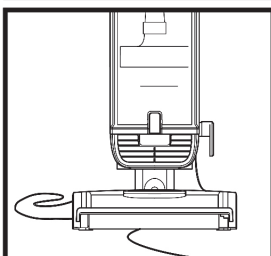

- DO NOT** pull or carry vacuum cleaner by the cord or use cord as a handle.
- DO NOT** unplug by pulling on the cord. Grasp the plug, not the cord.
- DO NOT** close the door on the cord.
- DO NOT** pull the cord around sharp corners.
- DO NOT** leave the cord near heated surfaces.

To minimize the risk of power cord damage, **DO NOT** run the vacuum over the power cord. If this occurs, immediately shut off power to the vacuum and remove the cord from the brushroll or nozzle.

## CHECKING FOR BLOCKAGES

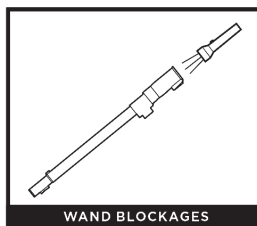

**WAND BLOCKAGES**

Detach wand from floor nozzle and handle, and check both ends for blockages.

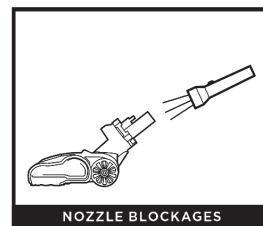

**NOZZLE BLOCKAGES**

Detach floor nozzle from wand and vacuum pod, tilt nozzle neck back, and check opening for blockages.

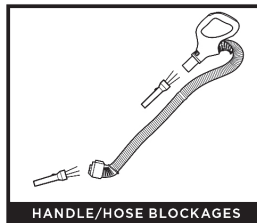

**HANDLE/HOSE BLOCKAGES**

Detach handle from wand and hose from the vacuum pod, and check openings for blockages.

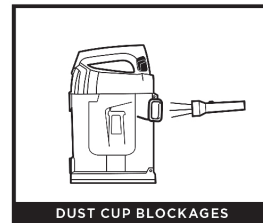

**DUST CUP BLOCKAGES**

Detach dust cup from vacuum pod. Empty dust cup, remove debris from lint screen, and check for blockages.

## TROUBLESHOOTING

### Power cord caught in brushroll or floor nozzle.

- To minimize the risk of power cord damage, **DO NOT** run the vacuum over the power cord. If this occurs, immediately shut off power to the vacuum and remove the cord from the brushroll or nozzle.
- Inspect power cord and plug for any damage before use. **DO NOT** use vacuum cleaner with a damaged cord or plug. Turn off all controls before plugging in or unplugging the vacuum cleaner. Store your vacuum cleaner with the power cord secured around the two cord hooks.

### Vacuum is not picking up debris. No suction or light suction.

- Check filters to see if they need cleaning. Follow instructions for rinsing and air-drying the filters before reinstalling.
- Dust cup may be full; empty dust cup.
- Clear any blockages in the hose, hose connections, nozzle, wand, pod, or accessories. See Checking for Blockages section for more information.
- If any hair is wrapped around the brushroll, continue vacuuming. This will allow the self-cleaning brushroll to remove the hair wrap and send it to the dust cup. If some fibers remain wrapped around the brushroll after continued use, open the brushroll cover to remove them.

### Vacuum lifts area rugs.

- Make sure Power/Surface switch is set to Hard Floor (setting 1).
- Suction is powerful. Take care when vacuuming area rugs or rugs with delicately sewn edges.
- To minimize suction, set the suction control slider to MIN. See the Suction Control section for more information.

### Brushroll does not spin.

- If the brushroll indicator light turns red, immediately turn off and unplug the vacuum. Remove pod from floor nozzle and clear any blockages. Reconnect nozzle, plug in vacuum, and turn on power.
- With the power on, recline the handle, which will automatically turn on the brushroll.

### Vacuum turns off on its own or indicator light flashes red.

If your vacuum overheats, the thermostat will automatically turn off the motor. Follow these steps to restart:

- Turn vacuum off and unplug it.
- Empty dust cup and clean filters (see Emptying the Dust Cup and Cleaning the Filters).
- Check for blockages in hose, wand, nozzle, accessories, and inlet openings.
- Allow unit to cool for a minimum of 60 minutes.
- Plug in vacuum and turn it on.

804106580



PRINTED IN MEXICO Elbrd: J.E.  
OBPN: UV725\_Series\_IB\_E\_MP\_Mv8\_210120  
SC: 17-08-2021\_TAB MODEL: UV725\_B

# QUICK START GUIDE

Please be sure to read the enclosed Shark® Owner's Guide prior to using your unit.

## WHAT'S INSIDE:

- A** Vacuum Pod
- B** Floor Nozzle
- C** Handle & Hose
- D** Wand
- E** Pet Crevice Tool
- F** Upholstery Tool

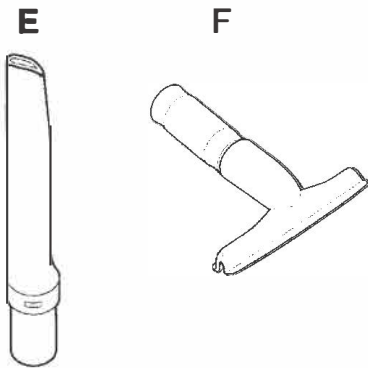

\*Accessories may vary depending on the model.

PRINTED IN MEXICO / Elbrd: J.E.

OBPN: UV725\_Series\_IB\_E\_MP\_Mv4\_200818

SC: 17-08-2021\_0.5P MODEL: UV725\_B

 804006580

## ASSEMBLY

1. Place pod onto **Floor Nozzle Post**.
2. Insert **Wand** into pod.
3. Insert **Handle** into wand.
4. Connect **Hose** to back of pod.

For proper operation, please ensure that all parts are firmly pressed until **CLICKED** in place.

