



# Navigator™ Pet Pro Upright Vacuum



It's important to read this instruction book prior to using your new product for the first time.

## IMPORTANT SAFETY INSTRUCTIONS

FOR HOUSEHOLD USE ONLY • PLEASE READ CAREFULLY BEFORE USE

If the plug does not fit fully into the outlet, reverse the plug. If it still does not fit, contact a qualified electrician. DO NOT force into outlet or try to modify to fit.

### WARNING

To reduce the risk of fire, electric shock, injury, or property damage:

#### GENERAL WARNINGS

- Your vacuum cleaner may consist of a motorized nozzle, wand, hose, and/or vacuum pod. This device contains electrical connections, electrical wiring, and moving parts that potentially present risk to the user.
- Use only identical replacement parts.
- Carefully observe and follow the instructions provided below to avoid improper use of the appliance. **DO NOT** use the vacuum for any purpose other than those described in this manual.
- Before use, carefully inspect all parts for any damage. **DO NOT** use if any parts are damaged.
- The use of an extension cord is **NOT** recommended.
- This vacuum cleaner contains no serviceable parts.
- Use extra care when cleaning on stairs.
- DO NOT** leave the vacuum cleaner unattended while plugged in.
- When powered on, keep the vacuum cleaner moving over the carpet surface at all times to avoid damaging the carpet fibers.
- DO NOT** place vacuum cleaner on unstable surfaces such as chairs or tables.
- Your Shark® vacuum may not be designed to stand up on its own. When taking a break from cleaning, you may need to lean it against furniture or a wall, or lay it flat on the floor. Using the vacuum for an application where the unit lacks stability may result in personal injury.

#### USE WARNINGS

- DO NOT** allow the appliance to be used by children. Close supervision is necessary when used near children. This is not a toy.
- Always turn off the vacuum cleaner before connecting or disconnecting any motorized nozzles or other accessories.
- DO NOT** handle plug or vacuum cleaner with wet hands.
- DO NOT** use without filters in place.
- Only use Shark® branded filters and accessories. Failure to do so will also void the warranty.
- DO NOT** damage the power cord:
  - DO NOT** pull or carry vacuum cleaner by the cord or use the cord as a handle.
  - DO NOT** unplug by pulling on cord. Grasp the plug, not the cord.
  - DO NOT** run the vacuum cleaner over the power cord, close a door on the cord, pull the cord around sharp corners, or leave the cord near heated surfaces.
- DO NOT** put any objects into nozzle or accessory openings. **DO NOT** use with any opening blocked; keep free of dust, lint, hair, and anything that may reduce airflow.
- DO NOT** use if nozzle or accessory airflow is restricted. If the air paths or the motorized floor nozzle become blocked, turn the vacuum cleaner off and unplug from electrical outlet. Remove all obstructions before you plug in and turn on the unit again.
- Keep nozzle and all vacuum openings away from hair, face, fingers, uncovered feet, or loose clothing.
- DO NOT** use if vacuum cleaner is not working as it should, or has been dropped, damaged, left outdoors, or dropped into water.
- Use only identical replacement parts.
- DO NOT** leave the vacuum cleaner unattended while plugged in.
- When powered on, keep the vacuum cleaner moving over the carpet surface at all times to avoid damaging the carpet fibers.
- DO NOT** place vacuum cleaner on unstable surfaces such as chairs or tables.
- Your Shark® vacuum may not be designed to stand up on its own. When taking a break from cleaning, you may need to lean it against furniture or a wall, or lay it flat on the floor. Using the vacuum for an application where the unit lacks stability may result in personal injury.
- DO NOT** use to pick up:
  - Liquids
  - Large objects
  - Hard or sharp objects (glass, nails, screws, or coins)
  - Large quantities of dust (drywall dust, fireplace ash, or embers). **DO NOT** use as an attachment to power tools for dust collection.
  - Smoking or burning objects (hot coals, cigarette butts, or matches)
  - Flammable or combustible materials (lighter fluid, gasoline, or kerosene)
  - Toxic materials (chlorine bleach, ammonia, or drain cleaner)
- DO NOT** use in the following areas:
  - Poorly lit areas
  - Wet or damp surfaces
  - Outdoor areas
  - Spaces that are enclosed and may contain explosive or toxic fumes or vapors (lighter fluid, gasoline, kerosene, paint, paint thinners, mothproofing substances, or flammable dust)
- Turn off all controls before plugging in or unplugging the vacuum.
- Unplug from electrical outlet when not in use and before any maintenance or cleaning.
- Hand wash with water only. Washing with cleaning chemicals could damage the unit.
- During cleaning or routine maintenance, **DO NOT** cut anything other than hair, fibers, or string wrapped around the brushroll.
- Allow all filters to air-dry completely before replacing in the vacuum to prevent liquid from being drawn into electric parts.
- Make sure the dust cup and all filters are in place after routine maintenance.
- If provided, secure the power cord around the two cord hooks during storage.

To reduce the risk of electric shock, this appliance has a polarized plug (one blade is wider than the other). This plug will fit in a polarized outlet only one way. If the plug does not fit fully in the outlet, reverse the plug. If it still does not fit, contact a qualified electrician to install the proper outlet. Do not change the plug in any way.

## SAVE THESE INSTRUCTIONS

### ASSEMBLY

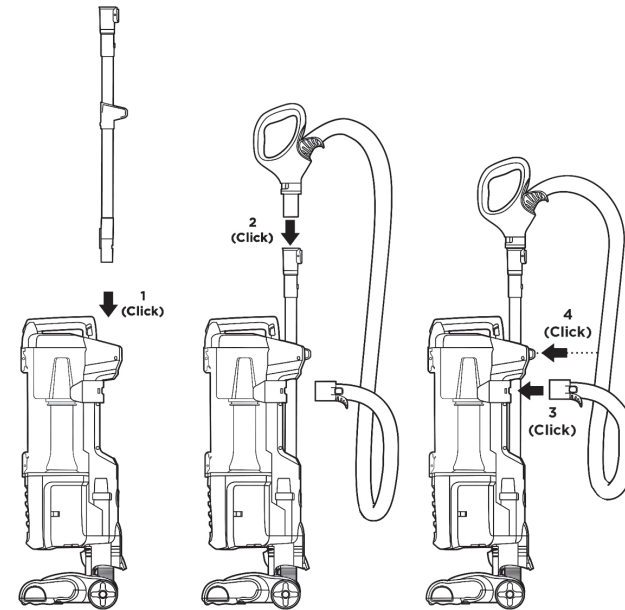

- Insert wand into pod.
- Insert handle into wand.
- Attach hose to back of vacuum pod.
- Attach hose to clip on wand.
- Store accessories on tool storage posts.

For proper operation, ensure all parts are firmly clicked into place.

**NOTE:** Accessories may vary depending on the model. Refer to quick guide, if available. \*The image shown here is for illustrative purposes only and may be subject to change.

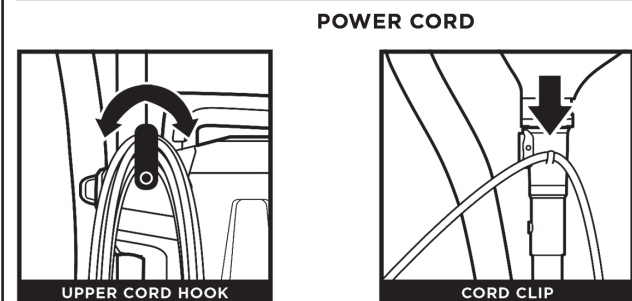
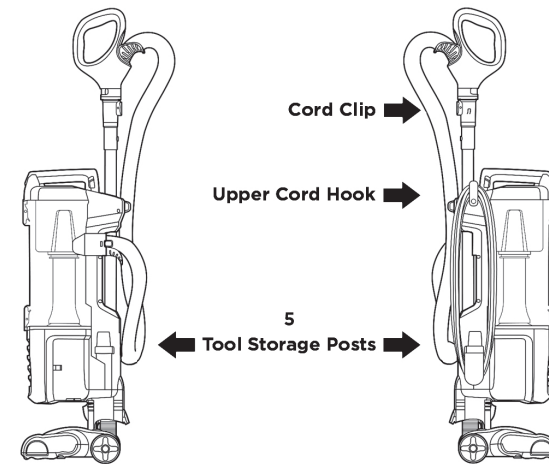

For cord access, rotate upper hook down and remove cord.

Use cord clip located on the side of wand to hold cord in place while vacuuming.

### WHOLE-HOME CLEANING

#### SETTINGS

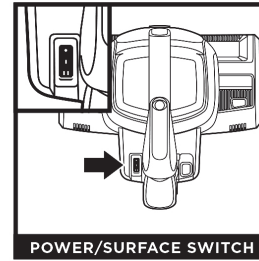

POWER/SURFACE SWITCH

Select surface setting:

- Power Off**
- I Hard Floor**  
For bare floors and small area rugs.
- II Carpet**  
For carpets.

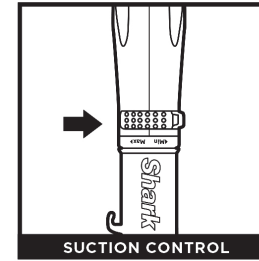

SUCTION CONTROL

Your Suction Control slider located on the top of the handle allows you to adjust your suction depending on your floor type.

**MIN:** to reduce suction and increase maneuverability on carpets.

**MAX:** to increase suction on bare floors.

#### BRUSHROLL INDICATOR LIGHT

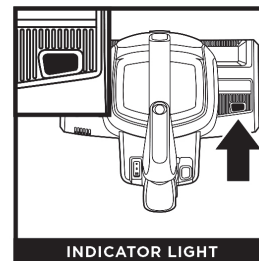

INDICATOR LIGHT

**WHAT DOES THE BRUSHROLL INDICATOR LIGHT MEAN?**

**Solid Green:** The brushroll is spinning and working as it should.

**Solid Red:** There is a jam in the brushroll area. Turn your vacuum off, unplug from the wall and remove any blockages in the nozzle.

**Flashing Red:** The motorized floor nozzle is overheating. Turn your vacuum off and wait a minimum of 45 minutes for it to cool down.

**NOTE:** For deep carpet cleaning per ASTM F608 (embedded dirt in carpets), set to **MAX** suction and use setting **II, Carpet**.

#### CLEANING MODES

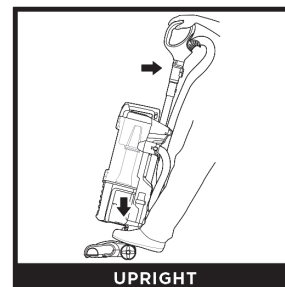

UPRIGHT

To engage brushroll, place foot on floor nozzle and tilt handle back.

\*Note: Your quick guide shows the accessories that are included with your model. The images shown here are for illustrative purpose only and may be subject to change.



ABOVE-FLOOR—HANDLE

Press the **Handle Release** button to detach the handle from the wand.

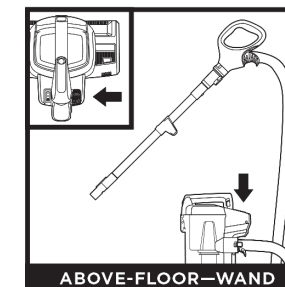

ABOVE-FLOOR—WAND

Press the **Wand Release** button to detach the wand from the pod.

**NOTE:** All accessories are compatible with both the wand and the handle.

### EMPTYING THE DUST CUP



**IMPORTANT:** Unplug the power cord before performing any maintenance.

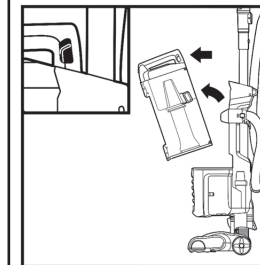

To remove **Dust Cup**, press button on top of dust cup handle. Tilt dust cup forward, then lift to remove.

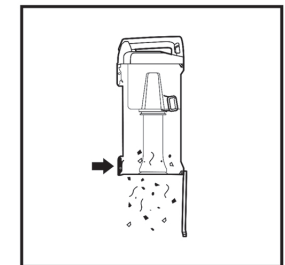

Press lower release button to open bottom of dust cup.

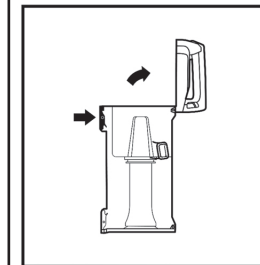

To remove collected debris from **Lint Screen**, press top release button and lift handle to open. Gently brush lint screen to clean.

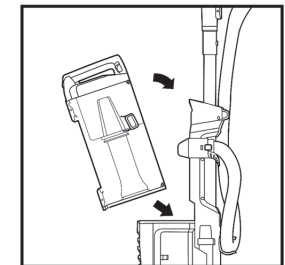

To reinstall, place bottom of dust cup into pod and then tilt back until it clicks into place.

### CLEANING AND REPLACING THE FILTERS

#### CLEANING FILTERS

Regularly clean and replace your filters to keep your vacuum's suction power optimal.

To clean filters, rinse with cold water only to prevent damage from cleaning chemicals. Allow all filters to air-dry for at least 24 hours before reinstalling them to prevent liquid from being drawn into electric parts.

**IMPORTANT:** DO NOT use soap when cleaning the filters.

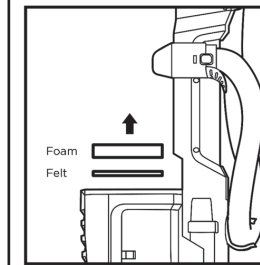

CLEAN PRE-MOTOR FILTERS EVERY 3 MONTHS

Remove **Dust Cup**, then lift out **Filters**.

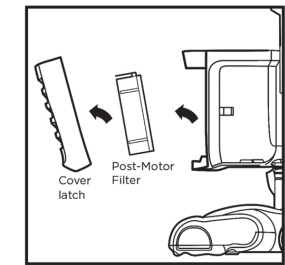

CLEAN HEPA FILTER EVERY YEAR

Press down top of **Filter Door**. Tilt **Filter Door** and lift out. Press tab at top of **HEPA Filter** and pull away from the base of the vacuum. To reinstall, insert HEPA filter into unit and replace the filter door.

#### REPLACING FILTERS

Follow the previous instructions for removing filters. The **Pre-Motor Filter** should be replaced every 2.5 years. The **HEPA Filter** should be replaced every 3 years.



Replacement Pre-Motor Foam & Felt Filter Kit

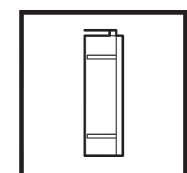

Replacement HEPA Filter

## MAINTENANCE

### Zero-M Technology ZERO-M

Shark's Zero-M™ self-cleaning brushroll delivers non-stop hair removal. If you run over a hard or sharp object or notice a noise change while vacuuming, check for blockages or objects caught in the brushroll.

NOTE: Do not be alarmed if there is visible hair wrap on the brushroll at any given time, as it should eventually make its way to the dust cup.

#### CLEANING THE BRUSHROLL

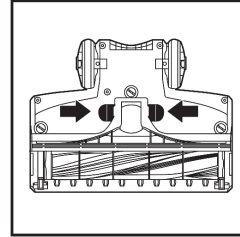
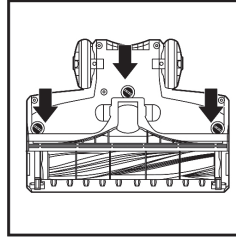

Using a coin, turn locks counterclockwise, then lift the door to access **Brushroll**.

#### DEBRIS WRAPPED AROUND BRUSHROLL

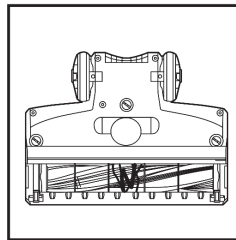

Clean off any debris on the bristles.

**NOTE:** If any hair is wrapped around the brushroll, extending cleaning time will allow Zero-M technology to remove it for you. If some fibers remain wrapped around brushroll after continued use, carefully cut debris with scissors and remove from brushroll.

#### DEBRIS BEHIND BRUSHROLL

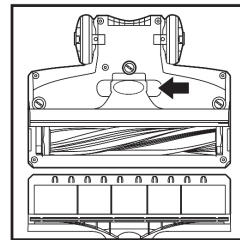

If you run over a **hard or sharp** object or notice a noise change while vacuuming, check for blockages or objects caught behind the brushroll.

Clear away any dust, dirt, or blockages in **Debris Intake**.

To close the cover, push down until it clicks into place, then close the locks with a coin.

## CHEKING FOR BLOCKAGES

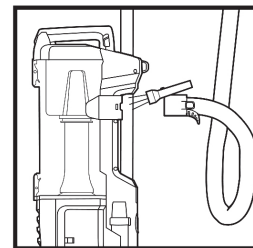

Detach hose from vacuum pod, and check hose and opening on back of pod for blockages.

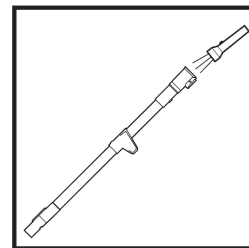

Detach wand from floor nozzle and handle, and check both ends for blockages.

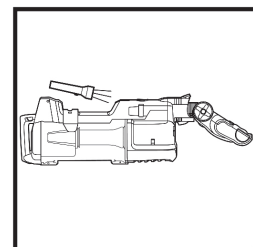

Detach wand from power unit, lay unit down, and check opening for blockages.

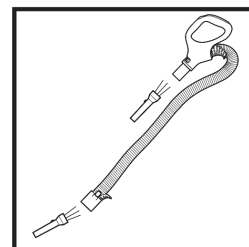

Detach handle from wand and hose from the vacuum pod, and check openings for blockages.

#### TECHNICAL SPECIFICATIONS

Voltage: 120V, 60Hz  
Amps: 9.5A

\*The image shown here is for illustrative purposes only and may be subject to change.

## CHEKING FOR BLOCKAGES CONT...

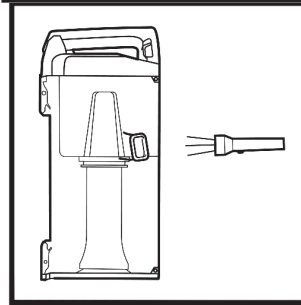

Detach dust cup from vacuum pod. Empty dust cup, remove debris from lint screen, and check for blockages.

## TROUBLESHOOTING

#### Vacuum is not picking up debris. No suction or light suction.

- Check filters to see if they need cleaning. Follow instructions for rinsing and air-drying the filters before reinserting in the vacuum.
- Dust cup may be full; empty dust cup.
- Check hose, hose connections, nozzle, wand, pod, and accessories for blockages. Clear any blockages found.

(Refer to Checking for Blockages section for more information.)

- If any string, carpet fibers, or hair is wrapped around the brushroll, extend cleaning time to allow Zero-M™ technology to remove it.
  - If some hair or fibers remain wrapped around brushroll after continued use, remove the floor nozzle cover and carefully cut debris with scissors and remove from brushroll. See Cleaning the Brushroll section for more information.

#### Vacuum lifts area rugs.

- Make sure Power/Surface switch is set to Hard Floor (setting I).
- Suction is powerful. Take care when vacuuming area rugs or rugs with delicately sewn edges.

#### Brushroll does not spin in carpet cleaning mode.

- If the Brushroll Indicator Light turns red, immediately turn off and unplug the vacuum. Remove pod from floor nozzle and clear any blockages. Reconnect nozzle, plug in vacuum, and turn on power.
- With the power on, recline the handle, which will automatically turn on the brushroll.
- Ensure that the Power/Surface switch is set to Carpet (setting II) for brushroll to spin.

#### Vacuum turns off on its own or indicator light flashes red.

This vacuum is equipped with a motor-protective thermostat. If your vacuum overheats, the thermostat will automatically turn the suction motor off. Perform the following steps to restart the thermostat:

1. Turn vacuum off and unplug it.
2. Empty dust cup and clean filters (see Emptying the Dust Cup and Cleaning the Filters).
3. Check for blockages in hose, accessories, and inlet openings.
4. Allow unit to cool for a minimum of 45 minutes.
5. Plug in vacuum and turn it on.
6. Restart the unit with the Power/Surface switch.

#### PLEASE READ CAREFULLY AND KEEP FOR FUTURE REFERENCE.

SharkNinja Operating LLC

Illustrations may differ from actual product. We are constantly striving to improve our products; therefore the specifications contained herein are subject to change without notice.

For SharkNinja U.S. Patent information, visit [www.sharkninja.com/USPatents](http://www.sharkninja.com/USPatents)

© 2018 SharkNinja Operating LLC. SHARK and SHARK NAVIGATOR are registered trademarks of SharkNinja Operating LLC. NAVIGATOR and ZERO-M are trademarks of SharkNinja Operating LLC.

804109574



PRINTED IN MEXICO / SC: 18.10.2019  
OBPN:ZU60Series\_IB\_E\_MP\_Mv4\_181218  
SHNMDL:ZU60\_B / TAB/ Elbrd:J.E.

W



Please be sure to read the enclosed Shark® Owner's Guide prior to using your unit.

# Shark Navigator™ Pet Pro



## QUICK START GUIDE

### WHAT'S INSIDE

- A Vacuum
- B Handle & Hose
- C Wand
- D Crevice Tool
- E Upholstery Tool

### ASSEMBLY

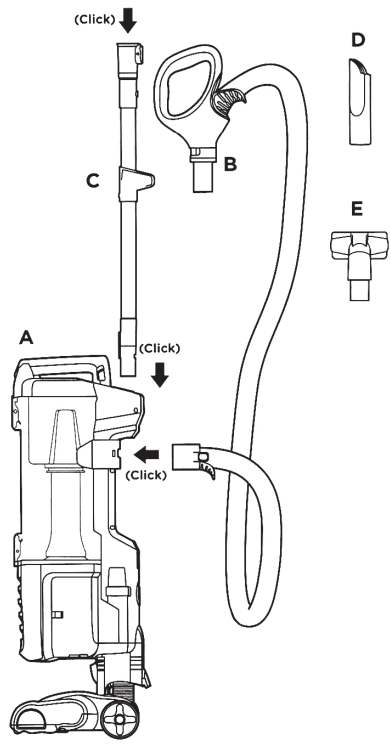

**NOTE:** For proper operation, ensure all parts are firmly **CLICKED** into place.

### EMPTYING THE DUST CUP

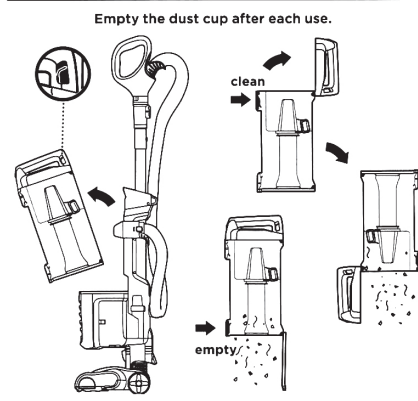

### MAINTENANCE

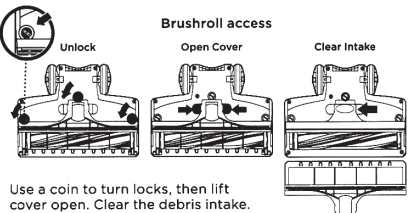
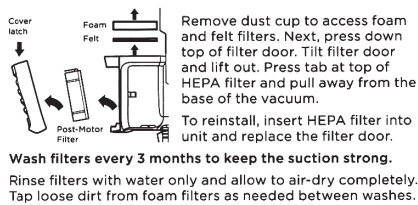

## 2 WAYS TO CLEAN

### FLOOR CLEANING

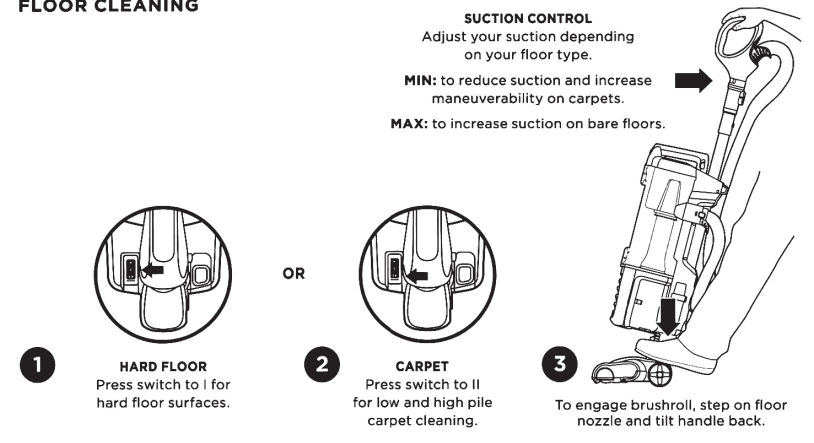

### ABOVE-FLOOR CLEANING

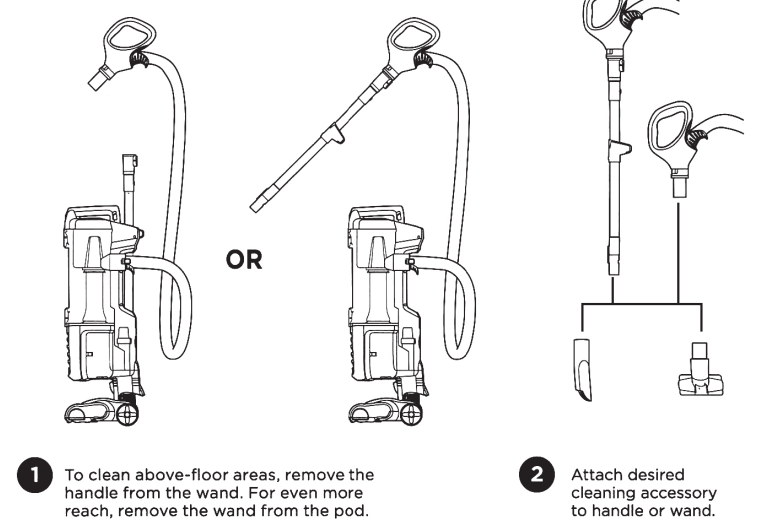

\*Accessories may vary depending on the model.

\* The image shown here is for illustrative purposes only and may be subject to change

804009574

PRINTED IN MEXICO / SC: 22.10.2019  
OBPN:ZU60\_QSG\_MP\_Mv3\_181212  
SHNMDL:ZU60\_B / 1P/ Elbrd:J.E.