

It's important to read this manual prior to using your new product for the first time.

## WARNINGS

# IMPORTANT SAFETY INSTRUCTIONS

## For Household Use Only

WHEN USING YOUR SHARK® CORDLESS VACUUM, BASIC SAFETY PRECAUTIONS SHOULD ALWAYS BE FOLLOWED, INCLUDING THE FOLLOWING:

READ ALL INSTRUCTIONS BEFORE USING YOUR SHARK® CORDLESS VACUUM.

### GENERAL ELECTRICAL SAFETY:

WARNING: TO REDUCE THE RISK OF FIRE, ELECTRIC SHOCK OR INJURY DO NOT USE OUTDOORS OR ON WET SURFACES.

- DO NOT use or charge the unit outdoors.
- DO NOT use or charge the unit on wet surfaces.
- DO NOT immerse vacuum cleaner, or charging adapter in water or other liquids.
- DO NOT handle vacuum, or charging adapter with wet hands.
- DO NOT use charging adapter if power cord has been damaged.
- DO NOT abuse the charging adapter cord. NEVER carry the charging adapter by the cord.
- DO NOT unplug the charging adapter by pulling on cord; to unplug, grasp the plug, not the cord.
- DO NOT use charging adapter with an extension cord. Plug adapter directly and only in a standard electrical outlet.
- DO NOT run the vacuum over the charging adapter cord.
- Keep charging adapter cord away from heated surfaces.
- DO NOT attempt to use this charging adapter with any other product nor attempt to charge this product with another charging adapter.
- Use only the charging adapter provided with the vacuum.
- Always turn the vacuum off before connecting or disconnecting the motorized floor brush.

### GENERAL USE:

- Use only on dry, indoor surfaces.
- Store the cordless vacuum indoors. Put the cordless vacuum away after use to prevent accidents.
- Use only as described in this manual. DO NOT use for any purpose other than described in this user's guide.
- Use only cleaning attachments supplied with this unit.
- Keep your work area well lit.
- Keep the vacuum moving over the carpet surface at all times to avoid damaging the carpet fibers.
- DO NOT put any objects into openings.
- DO NOT use with any opening blocked; keep free of dust, lint, hair and anything that may reduce airflow.
- DO NOT use the vacuum cleaner without dust cup and filter in place.
- DO NOT vacuum up any liquids.
- DO NOT pick up anything that is burning or smoking such as cigarettes, matches or hot ashes.
- DO NOT use to pick up flammable or combustible liquids such as gasoline or use vacuum in areas where their fumes may be present.
- DO NOT pick up toxic solutions such as chlorine bleach, ammonia or drain cleaner.
- DO NOT use in an enclosed space where vapors are present from paint, paint thinner, moth-proofing substances, flammable dust or other explosive or toxic materials.
- DO NOT run the vacuum over large-sized objects.

- DO NOT pick up hard or sharp objects such as glass, nails, screws or coins that could damage the vacuum cleaner.
- DO NOT place vacuum on unstable surfaces such as chairs or tables.
- Use extra care when cleaning on stairs.
- DO NOT allow the vacuum to be used as a toy.
- Close attention is necessary when used by or near children.
- DO NOT use cordless vacuum cleaner, or charging adapter if it has been dropped, damaged, left outdoors or submerged in water.
- Keep hair, face, loose clothing, fingers and all body parts away from openings and moving parts.
- This product includes rechargeable nickel metal hydride batteries. Batteries must be recycled or disposed of properly. Do not incinerate batteries or expose to high temperatures as they may explode.
- Leaks from battery cells can occur under extreme conditions. If the liquid gets on the skin, wash immediately with soap and water. If the liquid gets into the eyes, flush them immediately with clean water for a minimum of 10 minutes and seek medical attention.
- The battery must be removed from the appliance before the appliance is discarded.
- Batteries are to be recycled or disposed of safely.

### DUST CUP/FILTER:

- Before turning on the vacuum:
  - Make sure that the dust cup and filter are securely in place after routine maintenance.
  - Make sure that all components and filters are thoroughly dry after routine cleaning.

**Warning:** Changes or modifications to this unit not expressly approved by the party responsible for compliance could void the user's authority to operate the equipment.

**Note:** This equipment has been tested and found to comply with the limits for a Class B digital device, pursuant to Part 15 of the FCC Rules. These limits are designed to provide reasonable protection against harmful interference in a residential installation. This equipment generates, uses and can radiate radio frequency energy and, if not installed and used in accordance with the instructions, may cause harmful interference to radio communications.

However, there is no guarantee that interference will not occur in a particular installation. If this equipment does cause harmful interference to radio or television reception, which can be determined by turning the equipment off and on, the user is encouraged to try to correct the interference by one or more of the following measures:

- Re-orient or relocate the receiving antenna.
- Increase the separation between the equipment and receiver.
- Connect the equipment into an outlet on a circuit different from that to which the receiver is connected.
- Consult the dealer or an experienced radio/TV technician for help.

This device complies with Part 15 of the FCC Rules. Operation is subject to the following two conditions: (1) This device may not cause harmful interference, and (2) this device must accept any interference received, including interference that may cause undesired operation.

# SAVE THESE INSTRUCTIONS

## MAXIMIZING THE LIFE OF YOUR BATTERY

- To enhance battery life, this vacuum is equipped with an advanced feature that will shut off the vacuum when the battery is almost fully discharged. If the vacuum shuts off while in use, charge the unit until the complete oval around the power button is illuminated, indicating a full charge.
- Charge the vacuum for 7 hours before initial use. After initial use, each recharge will take 4 to 7 hours. A complete oval around the power button will illuminate for one (1) hour when the charge is complete.
- The precision charger monitors the batteries so you don't have to. A complete charge can take as little as 4 hours, but may take up to 7 hours because the charger monitors battery properties to extend battery life. Leaving the unit charging past the complete charge time will NOT harm the batteries.
- If the vacuum has never been used or has not been used for an extended period of time, it will take 3 to 5 complete charge and run down cycles to realize the full operational time of the vacuum.
- Do not store or charge in areas of high temperature or humidity.
- Use only the charge adapter supplied with this unit. If other chargers are used, the battery can fail causing damage to the battery, to the vacuum, or to personal property.

### BATTERY RECONDITIONING

If you experience shorter run time over the life of the vacuum, perform the following battery reconditioning steps. These steps can also be performed as monthly maintenance for maximum battery life.

- Charge the vacuum for a minimum of 7 hours.
- Run the vacuum until it turns itself off.
- Charge the vacuum for a minimum of 7 hours.

### BATTERY REMOVAL, REPLACEMENT AND DISPOSAL

The cordless vacuum is powered by Ni-Mh batteries, which must be recycled or disposed of properly in accordance with state, federal and local laws. If uncertain as to how to remove the battery pack, we suggest that you take your vacuum to a reputable small appliance service technician to have this service performed.

### BATTERY REMOVAL

- Ensure that the unit is Off.
- Never open the battery compartment except to replace or dispose of the battery pack.
- The battery door is on the bottom of the floor nozzle. Turn the unit over and push the sliding tab located next to the battery door to the unlock position. Slide and lift the battery door off of the nozzle.
- Remove the battery.
- Grasp the white connector terminals and push down on the lever with your thumb. Pull to disconnect.

### BATTERY REPLACEMENT

- Push the connector terminals together until they click into place.
- Replace the new battery pack into the battery compartment, taking care to tuck the wiring completely in so that the wiring does not interfere with the battery access door.

- Place the battery door onto the bottom of the nozzle, slide it back into place and move the sliding tab next to the door to the lock position.

### CAUTION:

- Use only with battery pack supplied.
- Never use ordinary batteries for replacement as these may leak and damage your vacuum.
- Do not attempt to remove the battery pack from the unit to charge.
- Never throw the battery pack or the appliance into a fire or incinerate it.
- Do not remove or damage the battery casing.
- Do not place the batteries on metal surfaces.
- Do not touch metal parts of the batteries together as the batteries will overheat.

## ASSEMBLY

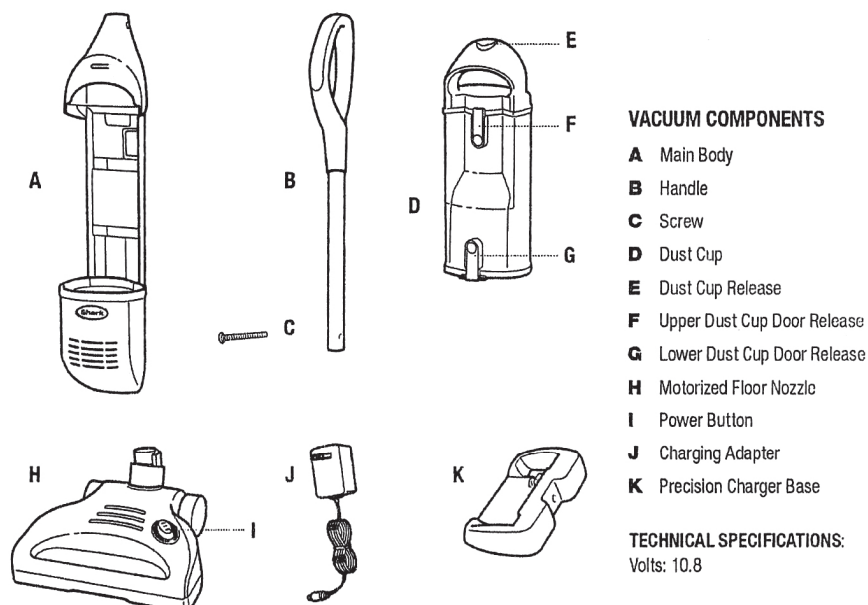

### VACUUM COMPONENTS

- A Main Body
- B Handle
- C Screw
- D Dust Cup
- E Dust Cup Release
- F Upper Dust Cup Door Release
- G Lower Dust Cup Door Release
- H Motorized Floor Nozzle
- I Power Button
- J Charging Adapter
- K Precision Charger Base

### TECHNICAL SPECIFICATIONS:

Volts: 10.8

Accessory type and quantity may vary depending on the model.

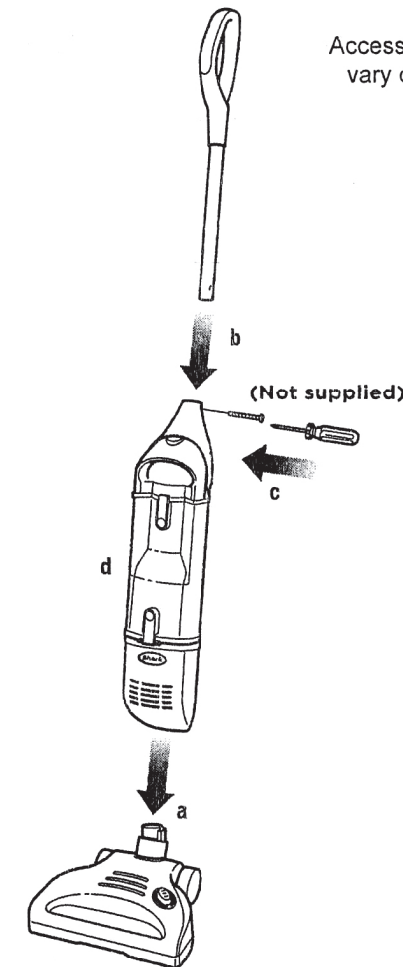

### ASSEMBLY

- Insert the vacuum body into the motorized brush. (a)
- Insert the handle pole into the top of the main body. (b)
- Use a screwdriver to secure the handle assembly in place with the bolt (taped to the handle during shipping). (c)
- Ensure that the dust cup is securely in place. (d)

## CHARGING

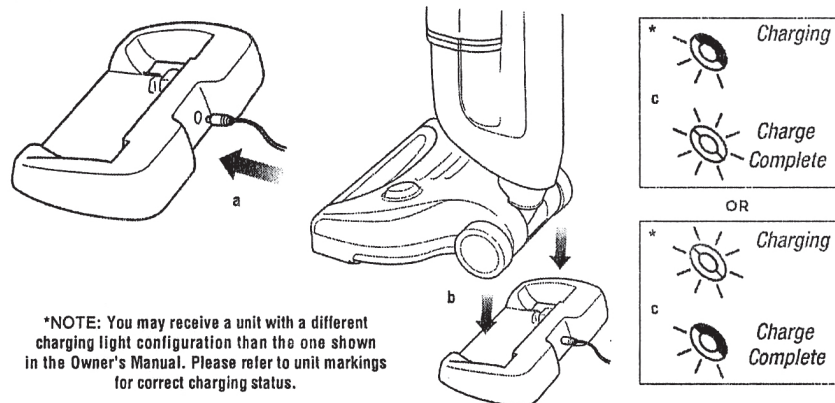

\*NOTE: You may receive a unit with a different charging light configuration than the one shown in the Owner's Manual. Please refer to unit markings for correct charging status.

- The charge adapter plug will fit into the precision charger base only one way. Insert the charging adapter plug by aligning the arrow on the plug with the arrow next to the charging jack on the back of the precision charging base. (a)
- Place the vacuum on the precision charger. Charge the unit for 7 hours before using the vacuum for the first time. (b)
- This unit is equipped with a precision charger that monitors the batteries to ensure a full charge for every use and to extend the life of the batteries. Depending on usage, the time for a full charge is 4 to 7 hours.
- One half of the blue LED light around the power button will illuminate while the unit is charging. When the charge is complete, the complete oval will be illuminated. (c) Approximately after one hour, the full charge lights will go off.

If the charging light does not illuminate, ensure that the charging adapter is plugged in properly to the wall outlet and to the back of the precision charger. Also ensure that the unit is properly seated in the precision charger.

USA 6

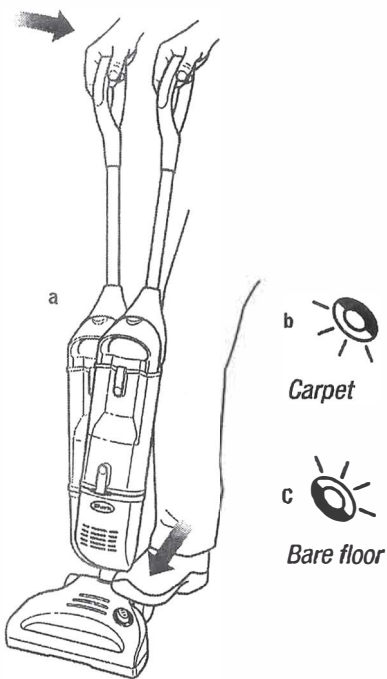

**USE YOUR CORDLESS VACUUM TO CLEAN BARE FLOORS, CARPETS AND RUGS.**

- Place your foot lightly on the top of the motorized floor nozzle and tilt the handle back to release the unit from the locked upright position. (a)
    - Lightly press the power button on the motorized floor brush with your foot to turn the vacuum on to a high speed optimized for carpet cleaning (b). On this setting, the vacuum will run for approximately 12 minutes.
    - Press the button again to switch to a lower speed optimized for bare floor cleaning (c). On this setting the vacuum will run for approximately 17 minutes. The LED lights around the power button will indicate your speed.
    - Press the button again to turn the unit off.
- IMPORTANT:** The indicator light around the power button will flash if the brush roll stops due to a jam. This feature is designed to protect the Lifetime Belt that powers the brushroll. See "Restarting After a Jam".

**CARE AND MAINTENANCE**

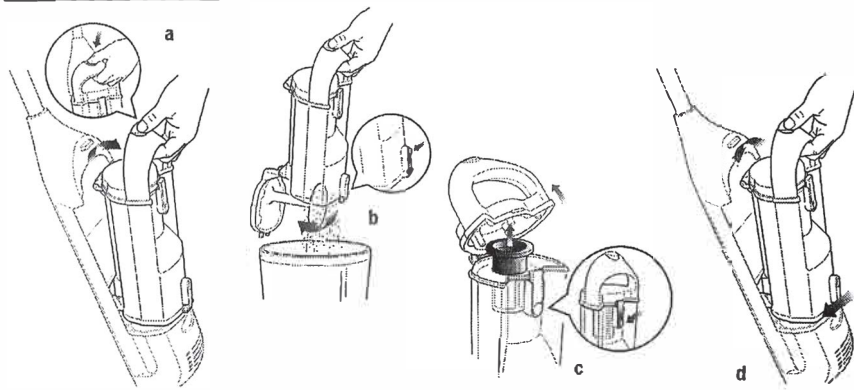

**EMPTYING THE DUST CUP**

To maintain the best performance of your vacuum, empty the dust cup after every use or as debris approaches the "MAX FILL" line. Never operate the vacuum without the dust cup and filter in place.

- Turn off the vacuum before removing the dust cup.
- Press down on the dust cup release button (a) and pull out the dust cup.
- Holding the carry handle, place the dust cup inside a trash receptacle and press the lower dust cup door release button. Gently tap the dust cup to dislodge and release dust and debris. (b)

**IMPORTANT:** If the Dust Cup Door does not swing open after pressing the release button, push the door open using the bottom door tabs.

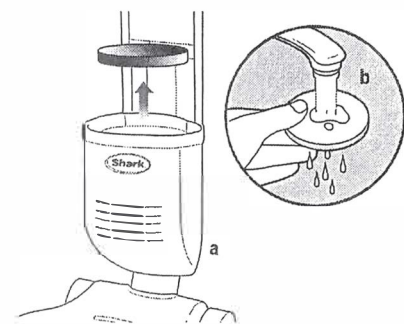

**CLEANING THE FILTER**

Your vacuum has a high efficiency dust cup to maintain strong suction by preventing debris from collecting on the filter. To maintain strong suction, it is important to clean the foam filter every month, under normal use.

- Turn off the vacuum and remove the dust cup.
- Remove the foam filter (a) and rinse under water until the water runs clear. (b) Squeeze the excess water out of the filter and let it air dry for 24 hours before replacing.

**DO NOT** use a hair dryer or other forced hot air to dry the filter.

**DO NOT** operate the vacuum without the filter in place.

**DO NOT** operate the vacuum with a wet filter.

**NOTE:** It is normal for your foam filter to discolor over time; it will not affect the filter performance.

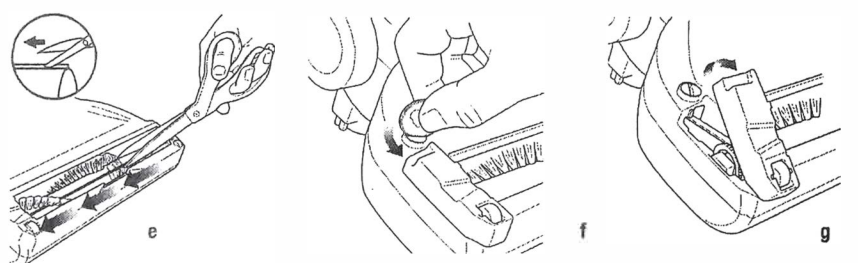

**CLEANING THE MOTORIZED FLOOR NOZZLE AND CLEARING BLOCKAGES**

An accumulation of hair, string, and other debris may sometimes become lodged in the flexible air hose of the motorized floor nozzle, in the air inlet of the dustcup or wrapped around the brush roll. These areas must be free from debris for maximum cleaning performance. To clear blockages and clean the brush roll:

- Ensure the vacuum is off.
- Press the release button located on the rear of the main body and remove the motorized floor nozzle. (c)
- To clear the air hose, flip back the connector to straighten the air passage (d) and carefully remove any debris lodged in the air hose. **DO NOT USE SCISSORS OR OTHER SHARP OBJECTS AS THESE MAY DAMAGE THE HOSE.**

Accessory type and quantity may vary depending on the model. The image shown here is for illustrative purposes only and may be subject to change.

Illustrations may differ from actual product. We are constantly striving to improve our products; therefore the specifications contained herein are subject to change without notice.

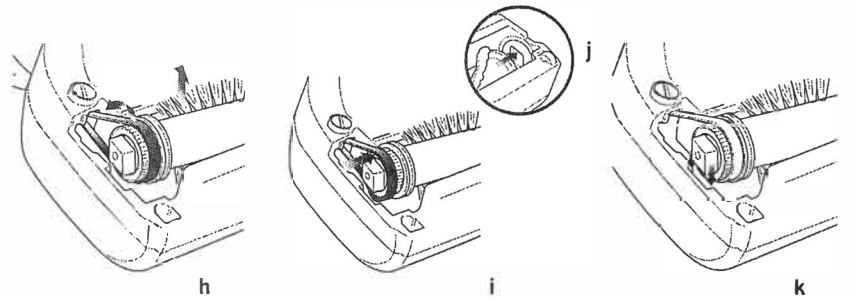

- Inspect the rotating brush for a build-up of debris. Remove anything wound around the brush by carefully cutting it with scissors. The brush roll is equipped with a raised cutting guide to make inserting scissors easier. Avoid damaging or cutting the bristles. (e)
- Use a flashlight to inspect inside the air duct at the bottom of the main body and remove any debris or blockages that may be there. Reattach the motorized floor nozzle, ensuring it clicks into place.
- Remove the dust cup and use the flashlight to check the air path on the spine of the vacuum and remove any debris or blockages. Then replace the dust cup.

**BRUSH BAR REMOVAL**

- For easier cleaning, the brush roll can be removed from the nozzle. Using a coin, turn the dial next to the brush roll access door to the unlock position. (f) Remove the brush roll access door. (g)
- Slip the black belt off of the white gear and lift out the brush roll. (h)

**BRUSH BAR INSERTION**

- To reinsert the brush roll, first slip the black belt onto the white gear (i), then align the white square on the opposite side of the brush roll into the square slot. (j)
- Align the white square on the belt side and position into its slot. (k)
- Replace the door, inserting the wheel side first. Use a coin to move the dial to the lock position.

**RESTARTING AFTER A JAM**

If the indicator light around the power button flashes, the brush bar has jammed and will cease to operate.

- Turn the unit off and allow it to cool down for 10 seconds.
- Ensure that nothing is blocking the motorized brush or wrapped around the brush bar.
- Turn the power on and the unit should operate normally.

**TROUBLESHOOTING GUIDE & REPLACEMENT PARTS**

PROBLEM	SUGGESTED SOLUTION
Vacuum will not operate.	<ol style="list-style-type: none"> <li>The battery may be depleted. Charge the vacuum until the complete oval around the power button is illuminated, indicating a complete charge.</li> <li>See "Restarting after a jam".</li> </ol>
Charging indicator does not illuminate.	<ol style="list-style-type: none"> <li>Check to see if the charge adapter is plugged in properly to the outlet and to the charging jack in back of the motorized floor nozzle.</li> <li>Ensure there is no debris accumulated on the metal charge contacts on the back of the motorized floor nozzle and on the charging adaptor.</li> <li>Ensure that the electrical outlet is supplying power to the charger. Check the fuse/breaker.</li> </ol>
Motorized brush will not work.	<ol style="list-style-type: none"> <li>See "Cleaning the Motorized Floor Nozzle and Clearing Blockages" and "Restarting after a jam".</li> <li>Ensure that the motorized floor nozzle is properly attached.</li> </ol>
Vacuum will not pick up or suction power is weak.	<ol style="list-style-type: none"> <li>Empty the dust cup container.</li> <li>Remove the dust cup filter, check for blockages and remove. Clean or replace the dust cup filter. Note: It is important to clean the dust cup filter every month.</li> <li>The battery may need to be charged, charge until the complete oval around the power button is illuminated.</li> <li>Ensure that the motorized floor nozzle is properly attached.</li> </ol>
Dust escapes from vacuum.	<ol style="list-style-type: none"> <li>Empty the dust cup container.</li> <li>Ensure that the filter is inserted completely into its holder below the dust cup.</li> <li>Check for punctures in dust cup filter or cracks in the dust cup and replace.</li> </ol>
Vacuum turns off on its own.	<ol style="list-style-type: none"> <li>Charge the unit until the complete oval around the power button is illuminated.</li> </ol>
Run time has decreased over time.	<ol style="list-style-type: none"> <li>Perform the following steps:                             <ol style="list-style-type: none"> <li>Charge the vacuum for a minimum of 7 hours.</li> <li>Run the vacuum until it turns itself off.</li> <li>Charge the vacuum for a minimum of 7 hours.</li> </ol> </li> </ol>



PRINTED IN MEXICO  
 OBPN: SV1106\_N\_40\_IB\_E\_F\_S\_141126\_4  
 SC: 04-16-2018\_10P MODEL: SV1106\_B  
 ReDesign\_Rev 1 22-09-2022 / J.E.