



Crystal Surround Air Track (Active Speaker System)

User manual

HW-FM35



PRINTED IN MEXICO
OBPN: AH68-02614B-00
SC: 07 - 02 - 2013 12P



8 0 4 1 0 4 6 6 4

Imagine the possibilities

Please read this manual carefully before operating your set and retain for future reference.

features

SoundShare

SoundShare produces TV sound on your SAT via a Bluetooth connection and controls the sound.

3D SOUND PLUS

The 3D SOUND PLUS feature adds depth and spaciousness to your listening experience.

Special Sound mode

You can select from 7 different sound modes - MUSIC, NEWS, DRAMA, CINEMA, SPORTS, GAME, and OFF (Original Sound) - depending on the type of content you want to enjoy.

Multi-function Remote Control

The supplied remote control can be used to control the TV connected to this unit. (Works only for Samsung TVs)

The remote control has a TV hotkey that enables you to perform various operations with the simple press of a button.

Active Speaker System

This unit features an Active Speaker System that provides high sound quality in a single slim unit.

This unit does not require any satellite loudspeakers or speaker cabling, which are normally associated with conventional surround sound systems.

USB Host support

You can connect and play music files from external USB storage devices such as MP3 players, USB flash memory, etc. using the Air Track's USB HOST function.

Bluetooth Function

You can use connect a Bluetooth device to the SAT and enjoy music with high quality stereo sound, all without wires!

LICENSE



Manufactured under license from Dolby Laboratories. Dolby and the double-D symbol are trademarks of Dolby Laboratories.



Manufactured under license under U.S. Patent Nos: 5,956,674; 5,974,380; 6,487,535 & other U.S. and worldwide patents issued & pending. DTS, the Symbol, & DTS and the Symbol together are registered trademarks & DTS 2.0 Channel is a trademark of DTS, Inc. Product includes software. © DTS, Inc. All Rights Reserved.



NOTES:

NOTES:

safety information

SAFETY WARNINGS

TO REDUCE THE RISK OF ELECTRIC SHOCK, DO NOT REMOVE THE COVER (OR BACK). NO USER-SERVICEABLE PARTS ARE INSIDE.
REFERSERVICING TO QUALIFIED SERVICE PERSONNEL.

	<div style="border: 1px solid black; padding: 5px; text-align: center;"> CAUTION RISK OF ELECTRIC SHOCK DO NOT OPEN </div>	
<p>The lightning flash and Arrowhead within the triangle are warning signs alerting you to dangerous voltage inside the product</p>	<p>CAUTION: TO REDUCE THE RISK OF ELECTRIC SHOCK, DO NOT REMOVE THE COVER (OR BACK). NO USER SERVICEABLE PARTS INSIDE. REFER SERVICING TO QUALIFIED SERVICE PERSONNEL.</p>	<p>The exclamation point within the triangle is a warning sign alerting you to important instructions accompanying the product.</p>

WARNING

- To reduce the risk of fire or electric shock, do not expose this appliance to rain or moisture.
- To prevent injury, this apparatus must be securely attached to the floor/wall in accordance with the installation instructions.

CAUTION

- Do not expose this apparatus to dripping or splashing. Do not put objects filled with liquids, such as vases on the apparatus.
- To turn this apparatus off completely, you must pull the power plug out of the wall socket. Consequently, the power plug must be easily and readily accessible at all times.

This product satisfies FCC regulations when shielded cables and connectors are used to connect the unit to other equipment. To prevent electromagnetic interference with electric appliances, such as radios and televisions, use shielded cables and connectors for connections.

FCC NOTE (for U.S.A):

This equipment has been tested and found to comply with the limits for a Class B digital device, pursuant to Part 15 of the FCC Rules. These limits are designed to provide reasonable protection against harmful interference in a residential installation.

This equipment generates, uses and can radiate radio frequency energy and, if not installed and used in accordance with the instructions, may cause harmful interference to radio communications. However, there is no guarantee that interference will not occur in a particular installation.

If this equipment does cause harmful interference to radio or television reception, which can be determined by turning the equipment off and on, the user is encouraged to try to correct the interference by one or more of the following measures:

- Reorient or relocate the receiving antenna.
- Increase the separation between the equipment and receiver.
- Connect the equipment to an outlet that is on a different circuit than the radio or TV.
- Consult the dealer or an experienced radio/TV technician for help.

Caution : FCC regulations state that any unauthorized changes or modifications to this equipment may void the user's authority to operate it.

Important Safety Instructions

Read these operating instructions carefully before using the unit. Follow all the safety instructions listed below. Keep these operating instructions handy for future reference.

- | | |
|---|---|
| <ol style="list-style-type: none"> 1) Read these instructions. 2) Keep these instructions. 3) Heed all warnings. 4) Follow all instructions. 5) Do not use this apparatus near water. 6) Clean only with dry cloth. 7) Do not block any ventilation openings. Install in accordance with the manufacturer's instructions. 8) Do not install near any heat sources such as radiators, heat registers, stoves, or other apparatus (including amplifiers) that produce heat. 9) Do not defeat the safety purpose of the polarized or grounding-type plug. A polarized plug has two blades with one wider than the other. A grounding type plug has two blades and a third grounding prong. The wide blade or the third prong are provided for your safety. If the provided plug does not fit into your outlet, consult an electrician for replacement of the obsolete outlet. | <ol style="list-style-type: none"> 10) Protect the power cord from being walked on or pinched particularly at plugs, convenience receptacles, and the point where they exit from the apparatus. 11) Only use attachment/accessories specified by the manufacturer. 12) Use only with the cart, stand, tripod, bracket, or table specified by the manufacturer, or sold with the apparatus. When a cart is used, use caution when moving the cart/apparatus combination to avoid injury from tip-over. 13) Unplug this apparatus during lightning storms or when unused for long periods of time. 14) Refer all servicing to qualified service personnel. Servicing is required when the apparatus has been damaged in any way, such as when the power-supply cord or plug is damaged, liquid has been spilled or objects have fallen into the apparatus, the apparatus has been exposed to rain or moisture, does not operate normally, or has been dropped. |
|---|---|



PRECAUTIONS

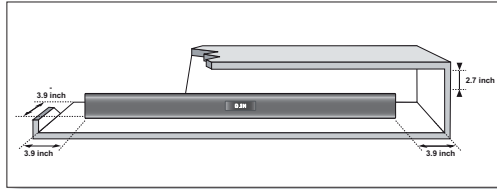

Ensure that the AC power supply in your house complies with the power requirements listed on the identification sticker located on the back of your product. Install your product horizontally, on a suitable base (furniture), with enough space around it for ventilation (3–4 inches). Make sure the ventilation slots are not covered. Do not place the unit on amplifiers or other equipment which may become hot. This unit is designed for continuous use. To fully turn off the unit, disconnect the AC plug from the wall outlet. Unplug the unit if you intend to leave it unused for a long period of time.



During thunderstorms, disconnect the AC plug from the wall outlet. Voltage peaks due to lightning could damage the unit.

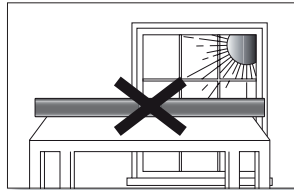

Do not expose the unit to direct sunlight or other heat sources. This could lead to overheating and cause the unit to malfunction.

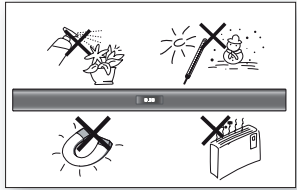

Protect the product from moisture (vases, coffee cups, etc.), and excess heat (fireplaces, heaters, etc.) or equipment creating strong magnetic or electric fields. Disconnect the power cable from the AC supply if the unit malfunctions. Your product is not intended for industrial use. This product is for personal use only.

Condensation may occur if your product has been stored in cold temperatures. If transporting the unit during the winter, wait approximately 2 hours until the unit has reached room temperature before using.

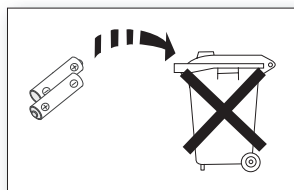

Do not dispose of batteries in the general household trash.

appendix

SPECIFICATIONS

Model name HW-FM35

GENERAL	Power supply	DC 24V	
	Standby power consumption	0.45W	
	Power consumption	Main unit	23W
		Subwoofer (PS-EW1-1)	
	USB	5V/0.5A	
	Weight	Main unit	3.86 lbs
		Subwoofer (PS-EW1-1)	6.61 lbs
	Dimensions (W x H x D)	Main unit	37.13 x 1.93 x 2.36 inches
Subwoofer (PS-EW1-1)		5.98 x 11.81 x 11.18 inches	
Operating temperature range	+41°F to +95°F		
Operating humidity range	10 % to 75 %		
AMPLIFIER	Rated output power	Main unit	30W/CH, 8OHM, THD = 10%, 1kHz
		Subwoofer (PS-EW1-1)	60W, 30HM, THD = 10%, 100Hz
	S/N ratio (analog input)	60dB	
	Separation(1kHz)	50dB	

* S/N ratio, distortion, separation and usable sensitivity are based on measurement using AES (Audio Engineering Society) guidelines.

*: Nominal specification

- Samsung Electronics Co., Ltd reserves the right to change the specifications without notice.

- Weight and dimensions are approximate.



As an ENERGY STAR Partner, Samsung has determined that this product or product models meets the ENERGY STAR guidelines for energy efficiency.

troubleshooting

Before requesting service, please check the following.

Symptom	Check	Remedy
The unit will not turn on.	<ul style="list-style-type: none"> Is the power cord plugged into the outlet? 	<ul style="list-style-type: none"> Connect the power plug to the outlet.
A function does not work when the button is pressed.	<ul style="list-style-type: none"> Is there static electricity in the air? 	<ul style="list-style-type: none"> Disconnect the power plug and connect it again.
Sound is not produced.	<ul style="list-style-type: none"> Is the unit properly connected to your TV? Is the Mute function on? Is the volume set to minimum? 	<ul style="list-style-type: none"> Connect it correctly. Press the Mute button to cancel the function. Adjust the volume.
The Picture does not appear on a TV when the function is selected.	<ul style="list-style-type: none"> Is the TV connected properly? 	<ul style="list-style-type: none"> Connect it correctly.
The remote control does not work.	<ul style="list-style-type: none"> Are the batteries drained? Is the distance between remote control and main unit too far? 	<ul style="list-style-type: none"> Replace with new batteries. Move closer to the unit.
The sound from the left/right channels are reversed.	<ul style="list-style-type: none"> Are the left/right audio output cables from the TV connected properly? 	<ul style="list-style-type: none"> Check the left/right channel and connect it/them correctly.
The SoundShare (TV pairing) failed.	<ul style="list-style-type: none"> Does your TV support SoundShare? Is your TV firmware the latest version? Does an error occur when connecting? Reset the TV MODE and connect again. 	<ul style="list-style-type: none"> SoundShare is supported by some Samsung TVs released after 2012. Check your TV to see if it supports SoundShare. Update your TV with the latest firmware. Contact the call center. Press ▶ button for 5 seconds to reset the product.

contents

FEATURES	2	Features
	2	License
2		
SAFETY INFORMATION	3	Safety warnings
	4	Precautions
3		
GETTING STARTED	6	Before reading the user's manual
	6	What's included
6		
DESCRIPTIONS	7	Front Panel
	8	Rear Panel
	8	Installing the ferrite core on the Subwoofer speaker cable
7		
REMOTE CONTROL	9	Tour of the remote control
9		
CONNECTIONS	10	Installing the wall mount
	11	Connecting an external device using Audio (Analog) cable or Optical (Digital) cable
10		
FUNCTIONS	12	Input mode
	12	Bluetooth
	14	SoundShare
	15	USB
	16	Using the remote control
	19	Software upgrade
12		
TROUBLESHOOTING	20	Troubleshooting
20		
APPENDIX	21	Specifications
21		

getting started

BEFORE READING THE USER'S MANUAL

Note the following terms before reading the user manual.

Icons used in this manual

Icon	Term	Definition
	Caution	Indicates a situation where a function does not operate or settings may be canceled.
	Note	Indicates tips or instructions on the page that help you operate a function.

Safety Instructions and Troubleshooting

- 1) Be sure to familiarize yourself with the Safety Instructions before using this product. (See page 3)
- 2) If a problem occurs, check Troubleshooting. (See page 20)

Copyright

©2013 Samsung Electronics Co.,Ltd.

All rights reserved; no part or whole of this user's manual may be reproduced or copied without the prior written permission of Samsung Electronics Co.,Ltd.

WHAT'S INCLUDED

Check for the supplied accessories shown below.

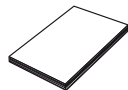

(Holder-screw:2EA)
(Screw:2EA)



Remote Control	User Manual	Bracket-Wall Mount	Screw	USB Cable
----------------	-------------	--------------------	-------	-----------



Power Cord	Adapter	Audio Cable	Toroidal Ferrite Core	USB converter
------------	---------	-------------	-----------------------	---------------

- The appearance of the accessories may differ slightly from the illustrations above.
- Use the dedicated USB cable to connect external USB devices to the unit.

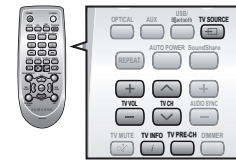

Using the TV functions (with Samsung TVs only)

- Press **TV SOURCE** on the remote control to change the TV's input source.
 - Press **TV INFO** on the remote control to display the TV channel information.
 - Press **TV CH** on the remote control to select the TV channel.
 - Press **TV VOL** on the remote control to increase or decrease the volume level.
 - Use **TV PRE-CH** button to move to the previous TV channel in TV mode.
- When you press the **SoundShare** button, the TV's sound is transmitted through the Air Track system via a Bluetooth connection. The Air Track also controls the sound volume, sound quality, etc.
 - The remote control can operate TVs made by SAMSUNG only.

SOFTWARE UPGRADE

Samsung may offer upgrades for the Crystal Surround Air Track's system firmware in the future.

If an upgrade is offered, you can upgrade the firmware by connecting a USB drive with the firmware upgrade stored on it to the USB port on your Air Track.

Note that if there are multiple upgrade files, you must load them onto the USB drive singly and use them to upgrade the firmware one at a time.

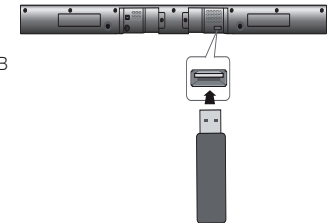

- Insert a USB drive containing the firmware upgrade into the USB port on the main unit.
- Do not disconnect the power or remove the USB drive while upgrades are being applied. The main unit will turn off automatically after completing the firmware upgrade. When software is upgraded, settings you have made will return to their default (factory) settings. We recommend you write down your settings so that you can easily reset them after the upgrade.
- Once upgrading the product software is completed, turn off the product and then press and hold (■) button for a while to reset the product.
- If the firmware fails to upgrade, we recommend formatting the USB device in FAT16 and trying again.
- For upgrading purposes, do not format the USB drive in NTFS format because it is not a supported file system.
- Depending on the manufacturer, some USB devices may not be supported.

functions

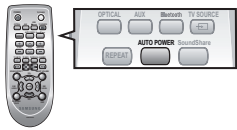

Using the AUTO POWER LINK function

The Crystal Surround Air Track is automatically turned on when you turn on the TV or any device connected to the Air Track with the optical cable.

Press **AUTO POWER** on the remote control of this unit.

- The Auto power link function turns on and off each time you press **AUTO POWER**.

AUTO POWER LINK	Display
ON	POWER LINK ON
OFF	POWER LINK OFF

- ☞ If a TV or any device connected to Air Track with the optical cable is off and there is no digital input, the Air Track is turned off after 20 minutes.

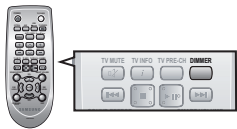

Using the DIMMER function

This feature control the brightness of the Display.

Press **DIMMER** on the remote control of this unit.

Each time the button is pressed, the selection changes as follows :
DIMMER ON ➔ DIMMER OFF

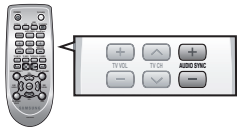

Using the AUDIO SYNC function

Video may appear out of synch with the audio if the Air Track is connected to a digital TV. If this occurs, adjust the audio delay time to match the video.

Press **AUDIO SYNC +/-** on the remote control of this unit.

- You can use the +, - buttons to set the audio delay time between 0 ms and 300 ms.

- ☞ In USB mode TV mode or BT mode, the Audio Sync function may not work.

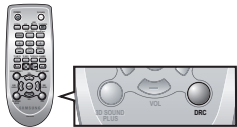

Using the DRC function

This feature balances the range between the loudest and quietest sounds. You can use this function to enjoy Dolby Digital sound when watching movies at low volume at night.

Press **DRC** on the remote control of this unit.

- Each time the button is pressed, the selection changes as follows :
DRC STANDARD ➔ DRC MAX ➔ DRC MIN

descriptions

FRONT PANEL

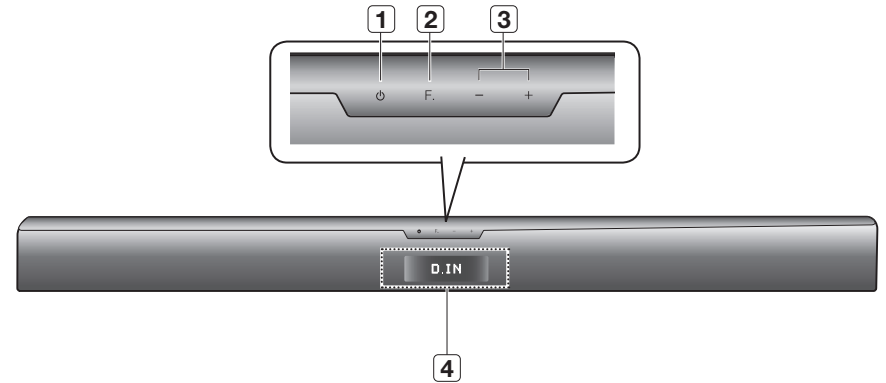

1	POWER BUTTON	Turns the Crystal Surround Air Track on and off.
2	FUNCTION BUTTON	Selects the D.IN, AUX, BT, TV, USB input. - While the unit is powered, pressing the (F.) button for more than 3 seconds sets the button to act as MUTE button. To cancel MUTE button setup, press (F.) button for more than 3 seconds again.
3	VOLUME +/-	Controls the volume level.
4	DISPLAY	Displays the current mode.

- ☞ When you turn on this unit, there will be a 4 to 5 second delay before it produces sound.

REAR PANEL

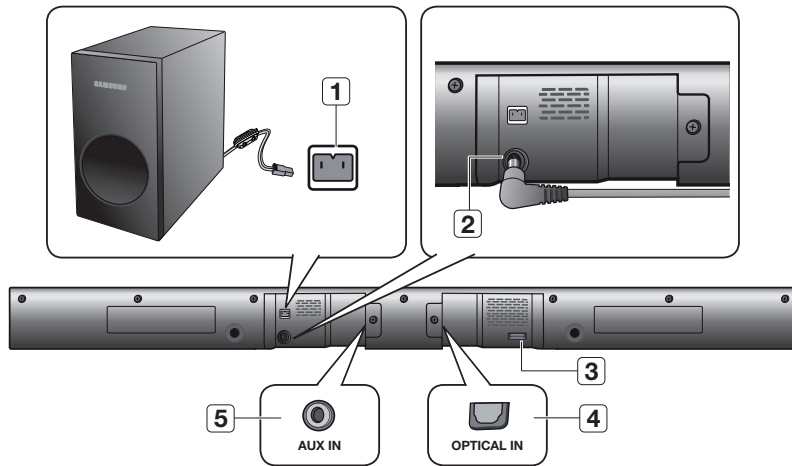

1	SUBWOOFER CONNECTOR TERMINAL	Connects the connector jack of the Subwoofer.
2	POWER SUPPLY IN	Connect the AC power adaptor jack to the power supply in jack, and then connect the AC power adaptor plug to a wall outlet.
3	USB PORT	Connect USB devices such as MP3 players here to the play files on the devices. - Use the supplied USB converter if you have installed the product on a wall.
4	OPTICAL IN	Connect to the digital (optical) output of an external device.
5	AUX IN	Connect to the Analog output of an external device.

- !**
- When disconnecting the power cable of the AC power adaptor from the wall outlet, pull the plug. Do not pull the cable.
 - Do not connect this unit or other components to an AC outlet until all connections between components are complete.

INSTALLING THE FERRITE CORE ON THE SUBWOOFER SPEAKER CABLE

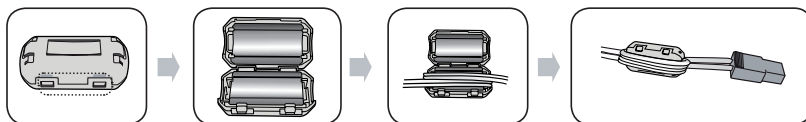

Lift up to release the lock and open the core.

Place the Subwoofer speaker cable on the opened core.

Close the lock.

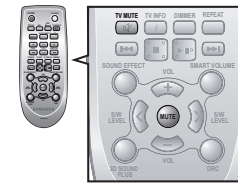

Muting the sound

This is useful when answering a doorbell or telephone call.

- To mute the sound of this unit, press the **MUTE** button on the remote control.
- To mute the TV, press the **TV MUTE** (🔇) button on the remote control.
- Press **MUTE/ TV MUTE** (🔇) on the remote control again (or press **VOLUME +/-**) to restore the sound.

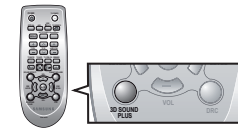

Using the 3D SOUND PLUS function

The 3D SOUND PLUS feature adds depth and spaciousness to the sound.

Press **3D SOUND PLUS** on the remote control.

- Each time the button is pressed, the selection changes as follows :
3D SOUND PLUS OFF ➔ 3D SOUND PLUS MUSIC ➔ 3D SOUND PLUS MOVIE

- When you turn on 3D Sound Plus, the Sound Effect function will automatically change to OFF.

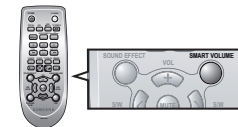

Using the SMART VOLUME function

This will regulate and stabilize the volume level against a drastic volume change caused by a channel change or scene transition.

Press **SMART VOLUME** on the remote control.

- Each time the button is pressed, the selection changes as follows :
SMART VOLUME ON ➔ SMART VOLUME OFF

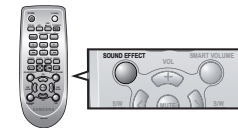

Using the Sound effect function

You can select from 7 different sound modes - MUSIC, NEWS, DRAMA, CINEMA, SPORTS, GAME, and OFF (Original Sound) - depending on the type of sources you want to enjoy.

Press **SOUND EFFECT** on the remote control.

- Select the **OFF** mode if you want to enjoy the original sound.

- We recommend that you select a Sound Effect based on the source material and your personal taste.
- When you choose a Sound Effect mode (except OFF), 3D Sound Plus will automatically be turned OFF.

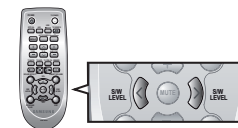

Using the S/W LEVEL function

You can control the base volume with the S/W Level button on the remote control.

- Press the **S/W LEVEL** button on the remote control.
- "**SW 0**" appears on the display.
- Press < or > button on the **LEVEL** key if you want to increase or decrease the subwoofer volume. You can set it from SW -6 to SW +6.

functions

- Connect USB devices directly to the USB port of the product. Otherwise, you may encounter a USB compatibility problem.
- Do not connect multiple storage devices to the product via a multi-card reader. It may not operate properly.
- Digital camera PTP protocols are not supported.
- Do not remove the USB device while it is being read.
- DRM-protected music files (MP3, WMA) from a commercial web site will not be played.
- External HDDs are not supported.
- Mobile phone devices are not supported.
- File Format Type Compatibility list:

Format	Codec
*.mp3	MPEG 1 Layer2
	MPEG 1 Layer3
	MPEG 2 Layer3
*.wma	Wave_Format_MSAudio1
	Wave_Format_MSAudio2
*.aac	AAC
	AAC-LC
	HE-AAC
*.wav	-
*.Ogg	OGG 1.1.0
*.Flac	FLAC 1.1.0, FLAC 1.2.1

※ Supporting Sampling Rate above 16KHz

USING THE REMOTE CONTROL



Play/Pause/Stop

During playback, press the ►||■ button.

- Press the ►|| button again to stop playing the file temporarily. Press the ►|| button to play the selected file.
- To stop playback, press the Stop (■) button during playback.



Skip Forward/Back

During playback, press the ◀◀,▶▶ button.

- When there is more than one file and you press the ▶▶ button, the next file is selected.
- When there is more than one file and you press the ◀◀ button, the previous file is selected.



Using the REPEAT function

Repeat playback allows you to repeatedly play a file, repeat all, randomly play files, or turn Repeat off.

Press the **REPEAT** button.

- **REPEAT OFF** : Cancels Repeat Playback.
- **REPEAT FILE** : Repeat playing a track.
- **REPEAT ALL** : Repeat playing all tracks.
- **REPEAT RANDOM** : Plays tracks in random order. (A track that has already been played may be played again.)



• You can set the REPEAT function during the playback of music from a USB drive.

remote control

TOUR OF THE REMOTE CONTROL

POWER BUTTON

Turns the Crystal Surround Air Track on and off.

AUX

Press the AUX mode.

OPTICAL

Press the Optical mode.

REPEAT

Select Repeat File, All, Random.

TV VOLUME

Adjusts the TV volume level.

TV CHANNEL

Switches between the available TV channels.

TV MUTE

Mutes the sound from the TV. Press again to restore the sound to the previous volume level.

CONTROL BUTTON

Play, pause, or stop playing a music file, or search forwards or backwards for a music file.

SOUND EFFECT

Selects the Sound Effect: (MUSIC, NEWS, DRAMA, CINEMA, SPORTS, GAME, OFF (Original Sound))

S/W LEVEL, VOLUME

Adjusts the Subwoofer level. Adjusts the volume level of the unit.

3D SOUND PLUS

This feature adds depth and spaciousness to the sound.

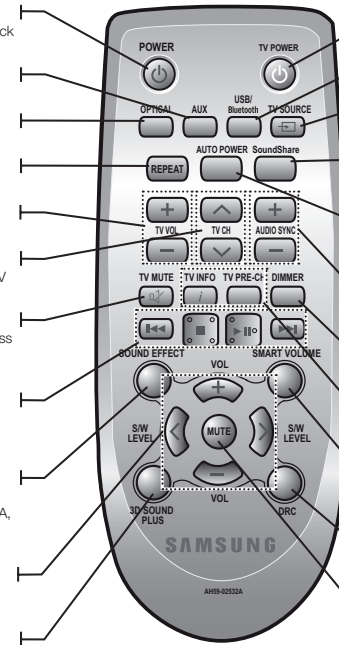

TV POWER BUTTON

Turns your Samsung TV on and off.

USB, BLUETOOTH
Press the USB/ BLUETOOTH mode.

TV SOURCE

Press to select a connected TV's video source.

SoundShare

This produces TV sound on your SAT via a Bluetooth connection and controls the sound.

AUTO POWER

Synchronizes the Air Track to a connected Optical source via the Optical jack so it turns on automatically when you turn on your TV.

AUDIO SYNC

Used to help sync video to audio when connected to a digital TV.

DIMMER

You can control the brightness of the Display.

TV INFO, TV PRE-CH

Displays the current TV status. Moves to the previous TV channel.

SMART VOLUME

Regulates and stabilizes the volume level against a drastic volume change.

DRC

You can use this function to enjoy Dolby Digital sound when watching movies at low volume at night (Standard, MAX, MINI).

MUTE

Mutes the sound from the unit. Press again to restore the sound to the previous volume level.



- SAT stands for Surround Air Track, which is Samsung's proprietary name.
- The remote control can operate TVs made by SAMSUNG only.
- Depending on the TV you are using, you may not be able to operate your TV with this remote control. If you can't, operate the TV using the TV's remote control.

Installing batteries in the Remote Control



1. Lift the cover at the back of the remote control upward as shown.
2. Install two AAA size batteries. (Not supplied) Make sure to match the "+" and "-" ends of the batteries with the diagram inside the compartment.
3. Replace the cover. Assuming typical TV usage, the batteries last for about one year.

Operational Range of the Remote Control

You can use the remote control up to 23 feet (7 meters) in a straight line from the unit. You can also operate the remote at a horizontal angle of up to 30° from the remote control sensor.

INSTALLING THE WALL MOUNT

You can use the wall mount bracket to mount this unit on a wall.

Installation Precautions

- Install on a vertical wall only.
- For the installation, avoid a location with high temperature or humidity, or a wall that cannot sustain the weight of the set.
- Check the strength of the wall. If the wall is not strong enough to support the unit, reinforce the wall or install the unit on different wall that can support the unit's weight.
- Purchase and use the fixing screws or mollys appropriate for the kind of wall you have (plaster board, iron board, wood, etc.). If possible, fix the support screws into wall studs.
- Connect cables from the unit to external devices before you install it on the wall.
- Make sure the unit is turned off and unplugged before you install it. Otherwise, it may cause an electric shock.

1. Place the wall mount bracket on a wall surface and then secure it with two screws (not supplied).
If you are hanging the unit below a TV, be sure to install the wall mount bracket so that the arrow (↑) is placed in the center of the TV.
Also make sure the unit is at least two inches (5 cm) below the TV.
2. Align the screw holders with the screw holes on the back of the Main Unit. Insert the supplied screws through the screw holders, and then screw them into the Main Unit.
3. Insert the USB converter into the unit before installing it on the wall.
4. Fit the unit into the corresponding slots of the wall mount bracket. For secure installation, make sure the mounting studs slide firmly down into the bottom of the slots.
5. The installation is complete.

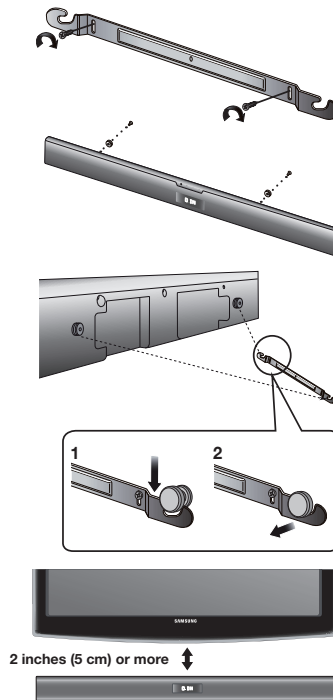

- Do not hang onto the installed unit and avoid any impact to the unit.
- Secure the unit firmly to the wall so that it does not fall off. If the unit falls off, it may cause an injury or damage the product.
- When the unit is installed on a wall, please make sure that children do not pull any of the connecting cables, as it may cause it to fall.
- For the optimal performance of a wall mount installation, install the speaker system at least 2 inches (5 cm) below the TV.

1. Turn on the Samsung TV and Air Track.
 - Set Add New Device in the TV's SoundShare Setting menu to On.
 2. When you change the mode of the Air Track to **TV**, a message asking whether to proceed with Bluetooth pairing is displayed. "[Samsung] AirTrack" appears on the TV screen.
 3. Select **<Yes>** on the TV screen. The pairing with the Air Track will be completed.
 - Once the pairing is established, when you change the Air Track to the TV mode from other input modes, it will automatically connect to the TV.
 - Changing the Air Track from TV mode to any other mode will cancel the SoundShare connection.
 - If you want to cancel the existing pairing of the SAT to a TV and pair your SAT to a different TV:
 - Press the **PLAY/PAUSE** button on the SAT for 5 seconds in the TV input mode to cancel the existing pairing. You can now pair it to a different TV.
 - In the SoundShare mode, you can control the volume and mute using either the TV remote or the SAT remote.
- TV SoundShare operation range
 - recommended pairing range: within 20 inches (within 50cm)
 - recommended operation range: within 16.25 ft. (5m)
 - If the distance between the Air Track and Samsung TV is over 16.25 ft. (5m), the connection or the sound can be cut off. If this occurs, connect to the Bluetooth device again within the operational range.
 - Make sure the Samsung TV's SoundShare mode is on before you use this function.
 - The **PLAY, NEXT, PREV, STOP** buttons will not work in the SoundShare mode.
 - Bluetooth Standby On function
 - Air Track will be powered on automatically when you turn the TV on if you connected TV and Air Track with SoundShare function.
 - You can toggle this function On/Off by pressing **(F)** button of front panel over 5 seconds when AirTrack is powered off. If set to Off, the product turns off automatically when the TV turns off, but it does not turn on automatically.
 - The SoundShare function is supported by some Samsung TVs released after 2012. Check whether your TV supports SoundShare before you begin. For more information, refer to the user's guide of your TV.

USB

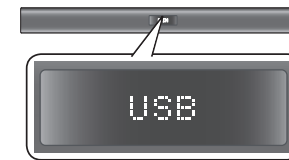

1. Connect the USB device to the USB port on the side of the unit.
2. Press the **(F)** button on the front panel of the Air Track repeatedly until **USB** appears.
3. **USB** appears on the display screen and then disappears.
 - The Crystal Surround Air Track connection is complete.
 - The SAT automatically turns off (Auto Power Off) if no USB device has been connected for more than 20 minutes.

Before you connect a USB device

Be aware of the following:

- If the file name of a folder on a USB device exceeds 10 characters, it is not displayed on the OLED.
- This product may not be compatible with certain types of USB storage media.
- The Air Track supports the FAT16 and FAT32 file systems.
 - The NTFS file system is not supported.

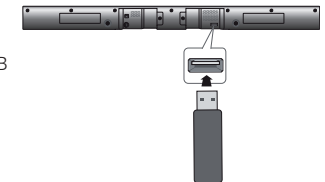

To disconnect the Bluetooth device from the Air Track

You can disconnect the Bluetooth device from the Air Track.
For instructions, see the Bluetooth device's user manual.

- The Air Track will be disconnected.
- When the Air Track is disconnected from the Bluetooth device the Air Track will display **BT DISCONNECTED** on the front display.

To disconnect the Air Track from the Bluetooth device

Press the **(F.)** button on the front panel of the Air Track to switch from **BT** to another mode or turn off the Air Track.

- The connected Bluetooth device will wait a certain amount of time for a response from the Air Track before terminating the connection.
(Disconnection time may differ, depending on the Bluetooth device)
- The currently connected device will be disconnected.

- 
 - In Bluetooth connection mode, the Bluetooth connection will be lost if the distance between the Air Track and the Bluetooth device exceeds 16.25 ft. (5m).
 - If the Bluetooth device comes back into the effective range after disconnecting, you can restart the Air Track to restore the pairing with the Bluetooth device.
 - The Air Track automatically turns off after 20 minutes in the Ready state.

SOUNDSHARE

This section explains how to connect the Crystal Surround Air Track to a Bluetooth compatible SAMSUNG TV.

To connect the Crystal Surround Air Track to a Bluetooth compatible Samsung TV

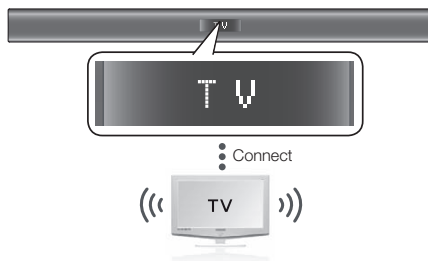

Press the **(F.)** button to select the **TV** mode, and then connect the TV to the Crystal Surround Air Track.

- The unit will play the TV's audio when it is connected to the TV.
- If you change to another mode, except the TV SoundShare mode, or turn off the Air Track, you will hear audio from the TV again.

<To pair to your TV>

To produce TV sound on your Air Track via a Bluetooth connection, you need to pair your system to the Bluetooth compliant TV first. Once the pairing is established, the pairing information is recorded and kept and no further Bluetooth connection message will appear. Bring the Air Track and the TV close together before pairing.

CONNECTING AN EXTERNAL DEVICE USING AUDIO (ANALOG) CABLE OR OPTICAL (DIGITAL) CABLE

This unit comes equipped with one optical in digital jack and one audio analog in jack, giving you two ways to connect it to a TV.

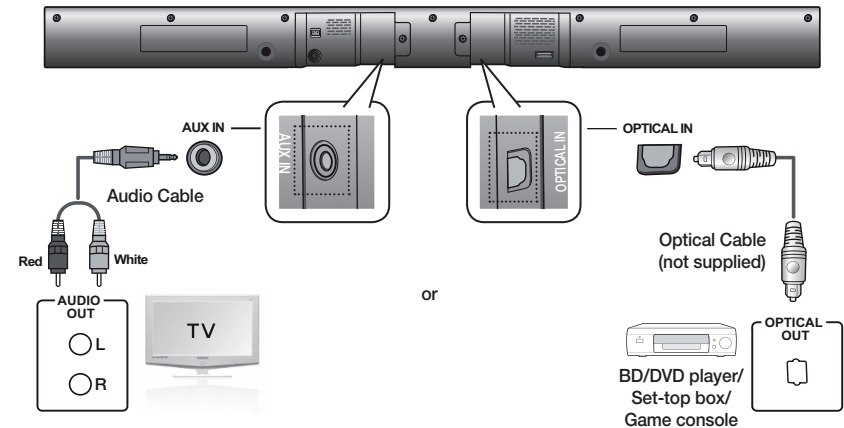

AUX IN

Connect AUX IN (Audio) on the main unit to the AUDIO OUT of the TV or Source Device.
Be sure to match connector colors.

or,

OPTICAL IN

Connect the Digital Input on the main unit to the OPTICAL OUT of the TV or Source Device.

- 
 - Do not connect the power cord of this product or your TV to the wall outlet until all connections between components are complete.
 - Before moving or installing this product, be sure to turn off the power and disconnect the power cord.

functions

INPUT MODE

You can select D.IN, AUX, BT, TV input or USB input.

Press an appropriate button on the remote control to select a desired mode, or press **(F.)** to select one from: D.IN, AUX, BT, TV or USB mode.

Input mode	Display
Optical Digital input	D.IN
AUX input	AUX
BLUETOOTH mode	BT
TV mode	TV
USB mode	USB

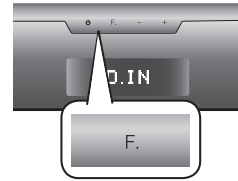

The unit turns off automatically in the following situations:

- BT/TV/USB/D.IN MODE
 - If there is no audio signal for 20 minutes.
- AUX Mode
 - If no KEY input is entered for 8 hours when the cable is connected.
 - If the AUX cable is disconnected for 20 minutes.

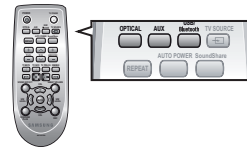

- Use the provided cable if a USB flash memory device cannot be connected directly to the unit.

BLUETOOTH

You can use a Bluetooth device to enjoy music with high quality stereo sound, all without wires!

What is Bluetooth?

Bluetooth is a technology that enables Bluetooth-compliant devices to interconnect easily with each other using a short wireless connection.

- A Bluetooth device may cause noise or malfunction, depending on usage, when:
 - A part of your body is in contact with the receiving/transmitting system of the Bluetooth device or the Air Track.
 - It is subject to electrical variation from obstructions caused by a wall, corner, or office partition.
 - It is exposed to electrical interference from same frequency-band devices including medical equipment, microwave ovens, and wireless LANs.
- Pair the Air Track with the Bluetooth device while they are close together.
- The further the distance is between Air Track and Bluetooth device, the worse the quality is. If the distance exceeds the Bluetooth operational range, the connection is lost.
- In poor reception-sensitivity areas, the Bluetooth connection may not work properly.
- The Bluetooth connection only works when the Bluetooth device is close to the set. The connection will be automatically cut off if the Bluetooth device is out of range. Even within range, the sound quality may be degraded by obstacles such as walls or doors.
- This wireless device may cause electric interference during its operation.

To connect the Air Track to a Bluetooth device

Check if the Bluetooth device supports the Bluetooth compliant stereo headset function.

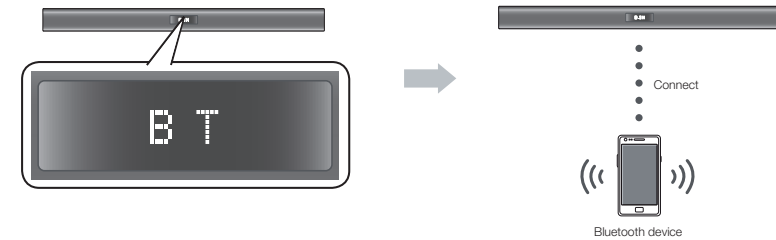

1. Press the **USB/Bluetooth** button on the remote control of the AirTrack to display the **BT** message.
 - You will see **WAIT** for 4 seconds and then **BT READY** on the front display of the Air Track.
2. Select the Bluetooth menu on the Bluetooth device you want to connect. (Refer to the Bluetooth device's user manual.)
3. Select the Stereo headset menu on the Bluetooth device.
 - You will see a list of scanned devices.
4. Select "[Samsung] AirTrack" from the list.
 - When the Air Track is connected to the Bluetooth device, it will display **BT CONNECTED** → **BT** on the front display.
 - If the Bluetooth device has failed to pair with the Air Track, delete the previous "[Samsung] AirTrack" found by the Bluetooth device and have it search for the Air Track again.
5. Play music on the connected device.
 - You can listen to the music playing on the connected Bluetooth device over the Crystal Surround Air Track system.
 - In BT mode, the Play/Repeat/Stop/Next/Prev functions are not available.

- You may be required to enter a PIN code (password) when connecting the Bluetooth device to the Air Track. If the PIN code input window appears, enter <0000>.
- The Air Track supports SBC data (44.1kHz, 48kHz).
- The AVRCP feature is not supported.
- Connect only to a Bluetooth device that supports the A2DP (AV) function.
- You cannot connect to a Bluetooth device that supports only the HF (Hands Free) function.
- Only one Bluetooth device can be paired at a time.
- Once you have turned off Air Track and the pairing is disconnected, the pairing will not be restored automatically. To reconnect, you must pair the device again.
- Search or connection may not be performed properly by Air Track in the following cases:
 - If there is a strong electrical field around Air Track.
 - If several Bluetooth devices are simultaneously paired with AirTrack
 - If the Bluetooth device is turned off, not in place, or malfunctions
 - Note that such devices as microwave ovens, wireless LAN adaptors, fluorescent lights, and gas stoves use the same frequency range as the Bluetooth device, which can cause electric interference.