

## Installation

- Do not place this apparatus near or over a radiator or heat register, or where it is exposed to direct sunlight.
- Do not place vessels (vases etc.) containing water on this apparatus, as this can result in a fire or electric shock.
- Do not expose this apparatus to rain or moisture.
- Be sure to contact a service center for information if you intend to install your TV in a location with heavy dust, high or low temperatures, high humidity, chemical substances, or where it will operate 24 hours a day such as in an airport, a train station, etc. Failure to do so may lead to serious damage to your TV.
- Do not expose this apparatus to dripping or splashing.

### Mounting the TV on a wall (Wall mount kit not supplied)



If you mount this TV on a wall, follow the instructions exactly as set out by the manufacturer. If it is not correctly mounted, the TV may slide or fall and cause serious injury to a child or adult and serious damage to the TV.

- Samsung Electronics is not responsible for any damage to the product or injury to yourself or others if you choose to install the wall mount on your own.
- Samsung is not liable for product damage or personal injury when a non-VESA or non-specified wall mount is used or when the consumer fails to follow the product installation instructions.
- You can install your wall mount on a solid wall perpendicular to the floor. Before attaching the wall mount to surfaces other than plaster board, contact your nearest dealer for additional information. If you install the TV on a ceiling or slanted wall, it may fall and result in severe personal injury.
- When installing a wall mount kit, we recommend you fasten all four VESA screws.
- If you want to install a wall mount kit that attaches to the wall using two top screws only, be sure to use a Samsung wall mount kit that supports this type of installation. (You may not be able to purchase this type of wall mount kit, depending on the geographical region.)
- Do not mount the TV at more than a 15 degree tilt.
- Standard dimensions for wall mount kits are shown in the table on the Quick Setup Guide.



Do not install your wall mount kit while your TV is turned on. This may result in personal injury from electric shock.









- Do not use screws that are longer than the standard dimension or do not comply with the VESA standard screw specifications. Screws that are too long may cause damage to the inside of the TV set.
- For wall mounts that do not comply with the VESA standard screw specifications, the length of the screws may differ depending on the wall mount specifications.
- Do not fasten the screws too firmly. This may damage the product or cause the product to fall, leading to personal injury. Samsung is not liable for these kinds of accidents.
- Always have two people mount the TV onto a wall.

### Providing proper ventilation for your TV

When you install your TV and One Connect Box, maintain a distance of at least 4 inches (10 cm) between the One Connect Box with other objects (walls, cabinet sides, etc.) to ensure proper ventilation. Failing to maintain proper ventilation may result in a fire or a problem with the product caused by an increase in its internal temperature.

- When you install your TV with a stand or a wall mount, we strongly recommend you use parts provided by Samsung Electronics only. Using parts provided by another manufacturer may cause difficulties with the product or result in injury caused by the product falling.

The remote control vary depend of model: The buttons on the remote control may have

Button	Description
 (Power)	Press to turn the TV on or off. For The Frame model, When watching TV, press to switch to Art mode. In Art mode, press to switch to the Media Home. Press and hold to turn off the TV completely.
 (Voice Assistant)	Runs Voice Assistant. Press and hold the button, say a command, and then release the button to run Voice Assistant. <ul style="list-style-type: none"> <li>The supported Voice Assistant's languages and features may differ by geographical region.</li> <li> Keep the remote more than 0.6 inches (15.24 mm) from your face when using and speaking to Voice Assistant through the mic on the remote.</li> </ul>
 (Settings - Number - Color button)	Each time you press this button, Settings menu / virtual numeric pad / Option pad with Color buttons are displayed alternately. <ul style="list-style-type: none"> <li>Use this button to access additional options that are specific to the feature in use.</li> <li>Press to bring up the virtual numeric pad on the screen. Use the numeric keypad to enter numeric values. Select numbers and then select <b>Done</b> or <b>Enter Number</b> to enter a numeric value. Use to change the channel, enter a PIN, enter a ZIP code, etc.</li> </ul>
 (Multi View)	Press the button to directly enter the Multi View function.
 (Directional button (up, down, left, right))	Use to navigate the menu or move the focus to highlight items on the Home Screen.
 Select	Selects or runs a focused item. When pressed while you are watching a broadcast program, detailed program information appears.
 (Return)	Press to return to the previous menu. When pressed for 1 second or more, the running function is terminated. When pressed while you are watching a program, the previous channel appears.

(Smart Hub)	Press to switch to the <b>Media Home</b> . From the <b>Ambient Mode</b> screen, press to switch to the <b>Ambient Mode Home</b> . For The Frame model, in <b>Art mode</b> , press to switch to the <b>Art Home</b> .
(Play/pause)	When pressed, the playback controls appear. Using these controls, you can control the media content that is playing. To use <b>Game Bar</b> , press and hold the button in <b>Game Mode</b> . <ul style="list-style-type: none"> <li>Game Bar may not be supported depending on the model or geographical area.</li> </ul>
(Volume)	Move the button up or down to adjust the volume. To mute the sound, press the button.
(Channel)	Move the button up or down to change the channel. To see the <b>Guide</b> screen, press the button. Press and hold the button up or down to quickly change the channel.
(Launch app button)	Launch the app indicated by the button. <ul style="list-style-type: none"> <li>Available apps may differ depending on the geographical area or contents provider.</li> </ul>
(Pairing)	If the Samsung Smart Remote does not pair to the TV automatically, point it at the front of the TV, and then press and hold the  and  buttons simultaneously for 3 seconds or more.

Use the Samsung Smart Remote less than 20 feet (6 m) from the TV. The usable distance may vary with the wireless environmental conditions.

- The images, buttons, and functions of the Samsung Smart Remote may differ with the model or geographical area.
- The Universal Remote function operates normally only when you use the Samsung Smart Remote that comes with the TV.
- It is recommended to use an original Samsung charger. Otherwise, it may cause performance degradation or failure of the product. In this case, the warranty service is not applicable.
- When the remote control does not work due to low battery, charge it by using the USB-C type port.

## Using Accessibility Functions (may differ with model)

### Accessing your TV's accessibility functions

The **Accessibility Shortcuts** button on your remote provides easy access to the accessibility functions on your TV.

- Press and hold the **Volume** button to display the **Accessibility Shortcuts** menu.
- Some functions may not appear depending on the access method.

### Voice Guide Settings

You can activate voice guides that describe the menu options aloud to aid the visually impaired. To activate this function, set **Voice Guide** to **On**. With **Voice Guide** on, the TV provides voice guides for channel change, volume adjust, information on current and upcoming programs, schedule viewing, other TV functions, various content in the Web Browser, and in Search.

- You can configure the volume, speed, pitch, and level of the **Voice Guide**.
- The **Voice Guide** is provided in the language that is specified on the **Language** screen. English is always supported. However, some languages are not supported by **Voice Guide** even though they are listed in the **Language** screen.

### TV Background Volume

By default, the volume of the broadcast content is set to be low so that you can hear the voice guide clearly. When the content volume is too low while the voice guide is coming out, you can adjust the content volume.

### Audio (Video) Description

You can activate an audio guide that provides an audio description of video scenes for the visually impaired. This function is only available with broadcasts that provide this service.

### Caption Settings

Set **Caption** to **On** to watch programs with the captions displayed.

- Captions are not displayed by programs that do not support captions.
- This function has no relationship with the features for controlling subtitles of DVD or Blu-ray players. To control DVD or Blu-ray subtitles, use the subtitle feature of the DVD or Blu-ray player and the player's remote control.

### Separate Closed Caption

- You can display the caption in the area separated from the broadcast screen.

### Caption Mode

- Default / CC1 ~ CC4 / Text1 ~ Text4**  
Operates in either analog TV channel mode or when a signal is supplied from an external device to the TV. (Depending on the broadcast signal, the analog caption function may or may not work with digital channels.)
- Default / Service1 ~ Service6 / CC1 ~ CC4 / Text1 ~ Text4**  
Works with digital channels. These functions may not be available in digital caption mode depending on the broadcast.

### Digital Caption Options

- You can change the font color, background color, size settings, and position, etc.
- The foreground and background colors and opacity settings cannot be the same.
  - The **Position** function is activated only for programs that support broadcast captions.

### Sign Language Zoom Settings

You can zoom in the sign language screen when the program you are watching provides it. First, set **Sign Language Zoom** to **On**, and then select **Edit Sign Language Zoom** to change the position and magnification of the sign language screen.

### Sign Language Guide Settings

Provides a description of menu items with sign language.

### Learn TV Remote

This function helps individuals with a visual impairment to learn the positions of the buttons on the remote control. When this function is activated, you can press a button on the remote control and the TV will tell you its name. Press the (**Return**) button twice to exit **Learn TV Remote**.

### Learn Menu Screen

Learn the menus on the TV screen. Once enabled, your TV will tell you the structure and features of the menus you select.

### Picture Off

Turn off the TV screen and provide only sound to reduce overall power consumption. When you press any button on the remote control with the screen off, the TV screen is returned to on.

### Multi-output Audio

You can turn on the TV speaker and a Bluetooth device at the same time. When this function is active, you can set the volume of the Bluetooth device higher than the volume of the TV speaker.

- This function may not be supported depending on the model or geographical area.

### High Contrast

You can change major service screens to white text on a black background or change the transparent TV menus to opaque so that text can be more easily read. To activate this function, set **High Contrast** to **On**.

### Enlarge

You can enlarge the size of the font on the screen. To activate, set **Enlarge** to **On**.

### Grayscale

You can change the color of the TV screen to a black and white tone to sharpen blurred edges caused by colors.

- If **Grayscale** is on, some **Accessibility** menus are not available.
- This function may not be supported depending on the model or geographical area.

### Color Inversion

You can invert the colors of the text and background for the setting menus displayed on the TV screen to make it easier to read them.

- If **Color Inversion** is on, some **Accessibility** menus are not available.
- This function may not be supported depending on the model or geographical area.

### Remote Button Repeat Settings

You can configure the operation speed of the remote control buttons so that they slow down when you continually press and hold them. First, set **Slow Button Repeat** to **On**, and then adjust the operation speed in **Repeat Interval**.

## 01 Connecting the TV to the One Connect Box

For more information about how to connect via the **One Connect Box**, refer to **Quick Setup Guide**.



- Do not use the **One Connect Box** in the upside-down or upright position.
- Take care not to subject the cable to any of the actions below. The **One Invisible Connection** contains a power circuit.



Bending



Twisting



Pulling



Pressing on



Electric shock

### CLASS1 LASER PRODUCT (One Invisible Connection)

- Caution - Invisible laser radiation when open. Do not stare into beam.**
  - Do not bend the **One Invisible Connection** cable excessively. Do not cut the cable.
  - Do not place heavy objects on the cable.
  - Do not disassemble either of the cable connectors.
- Caution - Use of controls, adjustments, or the performance of procedures other than those specified herein may result in hazardous radiation exposure.**

## 02 Initial Setup

When you turn on your TV for the first time, it immediately starts the **Initial Setup**. Follow the instructions displayed on the screen and configure the TV's basic settings to suit your viewing environment.

- When installing the 43LS03A/B model as a wall mount, it can be installed vertically and used.
  - Some features may not support portrait mode or full screen.
  - The initial setup is optimized for landscape mode.

## Using the TV Controller

You can turn on the TV with the **TV Controller** button at the lower right rear corner of the TV, and then use the **Control** menu. The **Control** menu appears when the **TV Controller** button is pressed while the TV is **On**.

- The screen may dim if the protective film on the bottom of the TV is not detached. Please remove the protective film.



**A** Control menu

**B** TV Controller button / Remote control sensor / Motion Sensor

- TV mode**
  - Press: **Move**
  - Press & Hold: **Select**
- Art mode**
  - Press: Switch to the TV mode.

- In **Art mode**, the **Remote control sensor** at the bottom of the TV remains off.

### Setting the sound sensor

You can turn on or off the sound sensor by using its switch at the lower right rear corner of the TV.

With the TV on, slide up the switch to turn the sound sensor on or down the switch to turn it off.

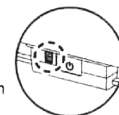

See the pop-up window on the TV to check whether the sound sensor is turned on or off.

- During analysis using data from the sound sensor, the data is not saved.

## 03 Troubleshooting and Maintenance

### Troubleshooting

For more information, refer to "Troubleshooting" or "FAQ" in the e-Manual.

> **Menu** > **Settings** > **Support** > **Open e-Manual** > **Troubleshooting** or **FAQ**

If none of the troubleshooting tips apply, please visit "www.samsung.com" and click **Support** or contact the Samsung service center.

- This TFT LED panel is made up of sub pixels which require sophisticated technology to produce. There may be, however, a few bright or dark pixels on the screen. These pixels will have no impact on the performance of the product.
- To keep your TV in optimum condition, upgrade to the latest software. Use the **Update Now** or **Auto Update** functions on the TV's menu ( > **Menu** > **Settings** > **Support** > **Software Update** > **Update Now** or **Auto Update**).

### The TV won't turn on.

- Make sure that the power cord is securely plugged in to the **One Connect Box** and the wall outlet.
- Make sure that the wall outlet is working and the remote control sensor at the bottom of the TV is lit and glowing a solid red.
- Try pressing the **TV Controller** button at the lower right rear corner of the TV to make sure that the problem is not with the remote control. If the TV turns on, refer to "The remote control does not work."

### The remote control does not work.

- Check if the remote control sensor at the bottom of the TV blinks when you press the button on the remote control.
  - When the remote's battery is discharged, charge the battery using the USB charging port (C-type), or turn over the remote to expose the solar cell to light.
- Try pointing the remote directly at the TV from 5 ft. to 6 ft. (1.5-1.8 m) away.
- If your TV came with a Samsung Smart Remote (Bluetooth Remote), make sure to pair the remote to the TV. To pair a Samsung Smart Remote, press the and buttons together for 3 seconds.

## 04 Specifications and Other Information

### Specifications

<b>Display Resolution</b> 3840 x 2160	<b>Operating Temperature</b> 50 °F to 104 °F (10 °C to 40 °C)
<b>Sound (Output)</b> 43"-50": 20 W 55"-85": 40 W	<b>Operating Humidity</b> 10 % to 80 %, non-condensing
	<b>Storage Temperature</b> -4 °F to 113 °F (-20 °C to 45 °C)
	<b>Storage Humidity</b> 5 % to 95 %, non-condensing

### Notes

- This device is a Class B digital apparatus.
- For information about the power supply, and more information about power consumption, refer to the information on the label attached to the product.
  - On most models, the label is attached to the back of the TV. (On some models, the label is inside the cover terminal.)
  - On **One Connect Box** models, the label is attached to the bottom of the **One Connect Box**.
- To connect a LAN cable, use a CAT 7 (\*STP type) cable for the connection. (100/10 Mbps)  
\* Shielded Twisted Pair
- The images and specifications of the **Quick Setup Guide** may differ from the actual product.

### Decreasing power consumption

When you shut the TV off, it enters **Standby** mode. In **Standby** mode, it continues to draw a small amount of power. To decrease power consumption, unplug the power cord when you don't intend to use the TV for a long time.

### REFURBISHED PRODUCT LIMITED NINETY DAYS WARRANTY

The **Refurbished Product Service Center** offers the following WARRANTY to the ORIGINAL purchaser of a product which we have refurbished.

This product that has been refurbished is warranted against any electronic or mechanical defects for a period of NINETY DAYS from the date of the original purchase by the consumer. Since this unit was sold as a refurbished item, the warranty does not apply to any cosmetic appearance items such as scratches. Should a defect occur, the **Refurbished Product Service Center** will repair or, at its option, replace defective unit/parts with new or rebuilt materials without charge for either parts or labor. Replacement unit/parts will be warranted for the remaining portion of the original warranty period.

This warranty does not cover installation or damage from accident, misuse, abuse, improper wiring, incorrect voltage, operating the unit against the instructions in the owner's manual or any product which has been opened, altered, or tampered with. This warranty does not cover costs for removal and/or installation of the unit for repair. Under no circumstances shall the service center be liable for any special, incidental or consequential damages or for any other expenses incurred by reason of use or sale of this product. This warranty is in lieu of any other warranties expressed or implied warranty of merchantability of fitness for particular use or otherwise.

This warranty gives the consumer specific legal rights and they may also have other rights which vary from State to State. Some States do not follow the exclusion or limitation of incidental or consequential damages, hence the above exclusion and limitations may not apply.

Refurbished Product Service Center  
13225 Marquardt Avenue Santa Fe Springs, CA 90670.

### WARRANTY REPAIR INFORMATION

If you need service on your unit and this product requires repair during the 90 days warranty period; please go to **www.ConsumerServiceRefurbish.com** or call the **Refurbished Product Service Center** at 562-946-3531 to obtain the required return authorization (RA) number. Pack the unit properly (the original carton is ideal for this purpose) along with a copy of your purchase receipt and a letter describing the problem. Send the unit freight prepaid and insured to:

Refurbished Product Service Center,  
Att: Customer Service Department 13225 Marquardt Avenue Santa Fe Springs, CA 90670

Your unit will be promptly repaired and returned to you. We will refuse to accept delivery of the returned unit unless the assigned RA number appears on the outside of the shipping carton.

Owner's Information  
(Keep for your permanent records)

NAME: \_\_\_\_\_

ADDRESS: \_\_\_\_\_

CITY: \_\_\_\_\_ STATE: \_\_\_\_\_ ZIP CODE: \_\_\_\_\_

PHONE: \_\_\_\_\_ E-MAIL: \_\_\_\_\_

MODEL: \_\_\_\_\_ SERIAL NO.: \_\_\_\_\_

804106602A



PRINTED IN MEXICO / SC: 15-09-2022  
SHNMDL: QN55LS03ADFXZA\_B  
OBPN: BN68-13710C-00 / TAB / Elbrd:J.E.

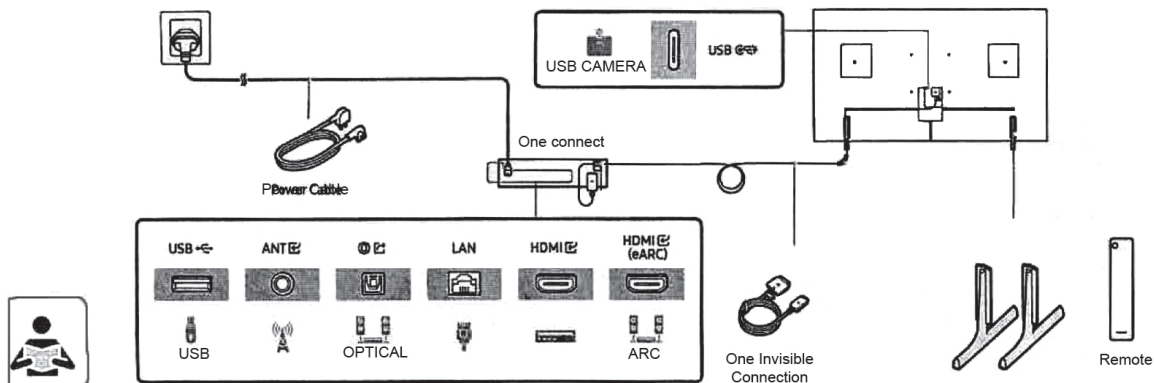

## 1

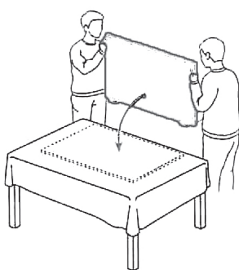

## 2

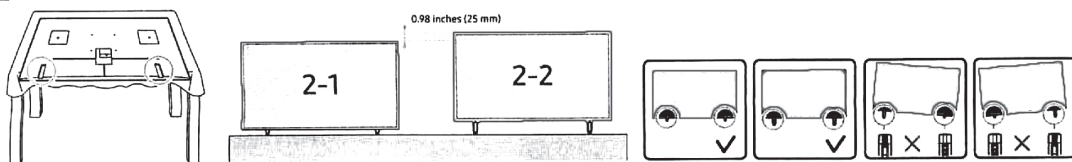

### 2-1

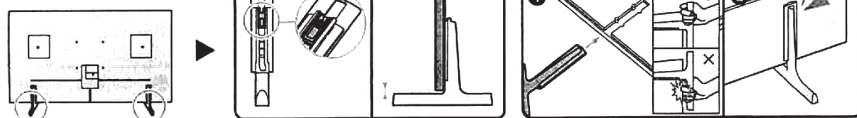

### 2-2

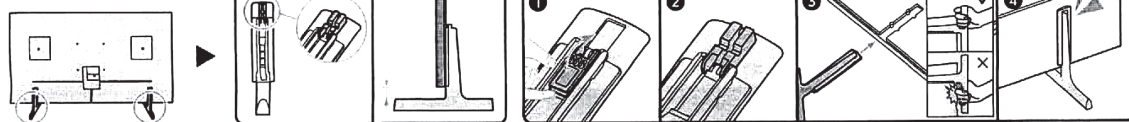

## 3

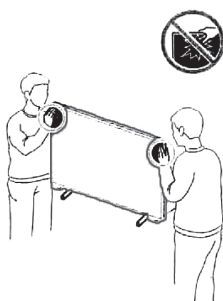

## 4

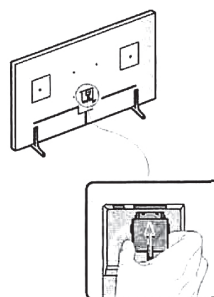

# 5

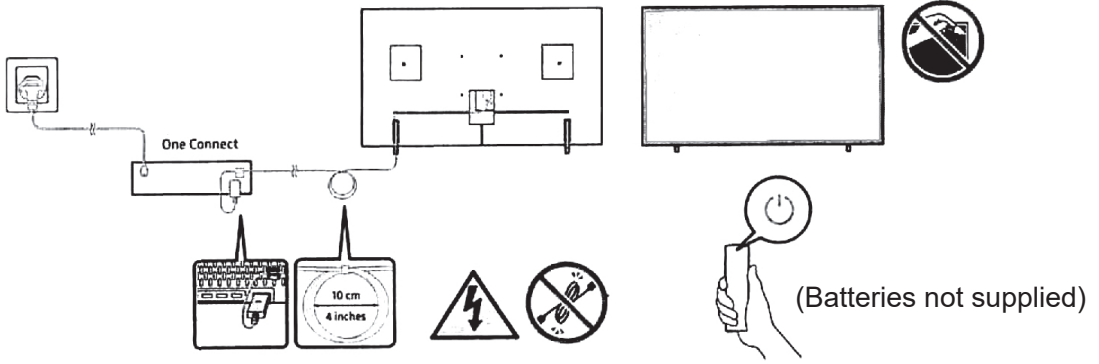

The remote control vary depend of model: The buttons on the remote control may have a different name or location than the remote control shows in this manual.

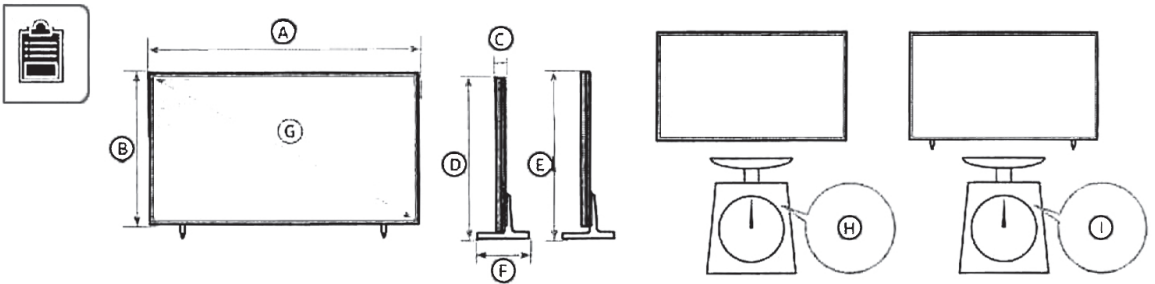

	A	B	C	D	E	F	G	H	I
QN55LS03B	48.7 inches (1237.9 mm)	27.9 inches (708.8 mm)	1.0 inches (24.9 mm)	29.3 inches (743.4 mm)	30.3 inches (768.4 mm)	9.0 inches (227.8 mm)	54.6 inches	37.3 lbs (16.9 kg)	38.1 lbs (17.3 kg)
QN65LS03B	57.4 inches (1456.8 mm)	32.8 inches (831.9 mm)	1.0 inches (24.9 mm)	34.2 inches (868.9 mm)	35.2 inches (893.9 mm)	10.3 inches (260.9 mm)	64.5 inches	49.4 lbs (22.4 kg)	50.3 lbs (22.8 kg)

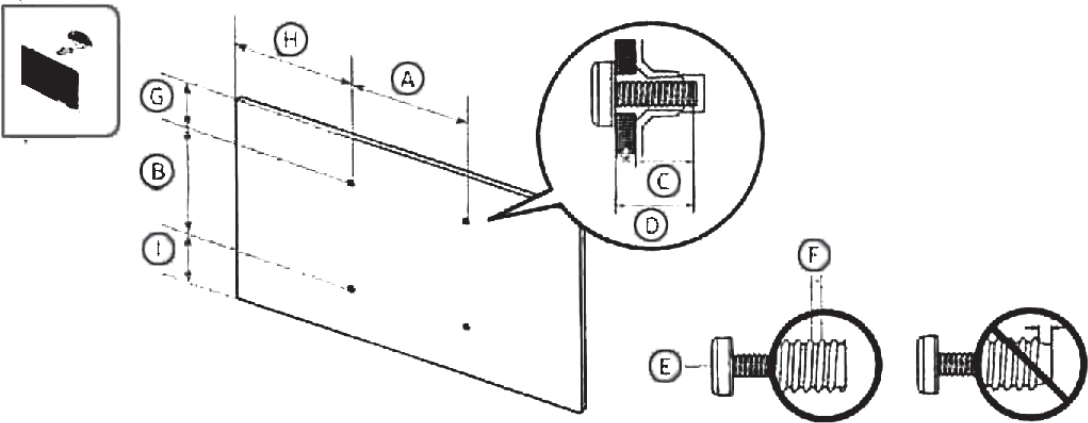

	VESA A x B (mm)	C (mm)	D	E x 4	F (mm)	G (inches)	H (inches)	I (inches)
QN55LS03B	200 x 200	10-12	C + ★	M8	1.25	9.5	20.4	10.5
QN65LS03B	400 x 300					10.5	20.8	10.4

★ : Wall-Mount Bracket

The image shown here is for illustrative purposes only and may be subject to change. The actual number of ports and their locations may vary depending on the model.